



STREET



170 ACCESSORIES

174 Clothing

175 BOLTS

180 Kit bolts

122 OIL TANK 'STREET'

117 FLUID COVERS

39 FOLD UP FOOTPEGS

162 FORK PRELOAD ADJUSTER

98 FRAME PROTECTORS

99 Frame protectors 'Easy'

101 Frame protectors 'Track'

103 Frame protectors 'Nylon-Track'

167 FRONT LIGHT GRID

145 GRIPS AND HANDLEBARS

74 HANDLEBAR ENDS

75 Handlebar ends 'Easy'

77 Handlebar ends 'Touring'

79 Handlebar ends 'Track'

80 Handlebar ends 'Titanium'

107 LEVER 'STREET'

110 Clutch Lever

111 Brake Lever

64 LEVER PROTECTION

71 Lever protection shield

84 LICENSE PLATE HOLDER

85 License plate holder 'Pista'

87 License plate holder 'Extreme'

93 License plate holder 'King'

96 License plate holder accessories

132 MIRRORS

142 Handlebar mirror hole cover

129 MIRROR HOLES COVERS

150 PASSENGER HANDLES AND SADDLEBAGS SUPPORTS

4 REARESETS

35 Footpegs with led

36 Original rearsets adjusters

5 Rearsets type 1

13 Rearsets type 1.5

21 Rearsets type 2.5

43 STANDS

44 Steel stands 'Pro'

46 Stands 'Race'

48 Stands 'Street'

50 General stands

54 STAND SUPPORTS

55 Stand supports 'Easy'

57 Stand supports 'Special'

59 Stand supports 'Track'

60 Stand supports 'Titanium'

125 STEM NUT

155 TURN LIGHT INDICATORS

160 Adapters of turn light indicators

112 WHEEL AXLE SLIDERS

170 ACCESSORI

174 Abbigliamento

43 CAVALLETTI

44 Cavalletti in acciaio 'Pro'

46 Cavalletti 'Race'

48 Cavalletti 'Street'

50 Cavalletti generici

117 COPERCHI SERBATOIO OLIO

125 DADO CANNOTTO

155 FRECCHE

160 Adattatori frecce

162 GHIERE PRECARICO FORCELLA

167 GRIGLIE FARO

107 LEVE 'STREET'

110 Leve frizione

111 Leve freno

150 MANIGLIE PASSEGGERO E SUPPORTI BORSA

145 MANOPOLE E MANUBRI

98 PARATELAI

99 Paratelai 'Easy'

101 Paratelai 'Track'

103 Paratelai 'Nylon-Track'

4 PEDANE

35 Poggiapiedi con led

36 Piastra arretramento pedana

5 Pedane tipo 1

13 Pedane tipo 1.5

21 Pedane tipo 2.5

39 POGGIPIEDI

84 PORTATARGA

85 Portatarga 'Pista'

87 Portatarga 'Extreme'

93 Portatarga 'King'

96 Accessori portatarga

64 PROTEZIONI LEVA

71 Paramani

112 PROTEZIONI PERNO RUOTA

122 SERBATOIO OLIO 'STREET'

132 SPECCHIETTI

142 Tappi fori specchi manubrio

54 SUPPORTI CAVALLETTO

55 Supporti cavalletto 'Easy'

57 Supporti cavalletto 'Special'

59 Supporti cavalletto 'Track'

60 Supporti cavalletto 'Titanio'

129 TAPPI FORI SPECCHI

74 TERMINALI MANUBRI

75 Terminali manubri 'Easy'

77 Terminali manubri 'Touring'

79 Terminali manubri 'Track'

80 Terminali manubri 'Titanio'

175 VITI

180 Kit viti

REARSETS



REARSETS TYPE 1

PEDANE TIPO 1



ENTIRELY MADE WITH CNC MACHINERY IN ERGAL 7075 T5 ALLOY, TYPE 1 REARSETS ARE DEVELOPED FOR STREET/RACING USE. FOOTPEGS AND FRONTPEGS ARE MADE IN ALUMINUM ALLOY MACHINED TO OBTAIN OPTIMAL GRIP. SHIFT AND BRAKE LEVERS ARE MOUNTED ON TWO BALL BEARINGS TO AVOID ANY FRICTION. REARSETS ARE PROVIDED WITH THE CORRECT LENGTH SHIFT ROD, SHIFT AND BRAKE BALL JOINTS. ALL SPARE PARTS ARE AVAILABLE.

INTERAMENTE REALIZZATE IN ERGAL 7075 T5 LAVORATO SU CENTRI DI LAVORO CNC QUESTO MODELLO DI PEDANE È STATO SVILUPPATO PER UN USO STRADALE E PISTA. I POGGIAPIEDI E I PUNTALINI IN ALLUMINIO SONO LAVORATI PER GARANTIRE UN GRIP OTTIMALE. LEVE CAMBIO E FRENO SONO MONTATE ENTRAMBE SU 2 CUSCINETTI A SFERA PER RIDURRE AL MINIMO L'ATTRITO. IL KIT COMPRENDE TUTTA LA VITERIA NECESSARIA PER IL MONTAGGIO, L'ASTA CAMBIO DELLA CORRETTA LUNGHEZZA E GLI SNODI SFERICI LATO CAMBIO E LATO FRENO. PER LE PEDANE VMC SONO SEMPRE DISPONIBILI TUTTI I RICAMBI.

00
BLACK - NERO

SPARE PARTS | TYPE 1

RICAMBIO | TIPO 1



FRONT PEG (SINGLE)
PUNTALINO SINGOLO

RP07S

00
BLACK - NERO



FOOTPEG FOR BEARINGS (SINGLE)
POGGIAPIEDE SINGOLO PER CUSCINETTI

RP48BS

00
BLACK - NERO



FOOTPEG WITH BUSHING (SINGLE)
POGGIAPIEDE SINGOLO CON BRONZINA

RP48S

00
BLACK - NERO



PLASTIC FOOTPEGS PROTECTIONS (PAIR)
TAPPI PROTEZIONE PEDANE (COPPIA)

AR48



Ø6 UNIBALL (MALE) RIGHT
SNODO Ø6 PASSO DESTRO MASCHIO

RP15



Ø6 UNIBALL (MALE) LEFT
SNODO Ø6 PASSO SINISTRO MASCHIO

RP15A



Ø8 UNIBALL (FEMALE)
TESTA A SNODO Ø8 FEMMINA

RP17



ALU HEEL PROTECTORS
ALETTE PARATACCO IN ALLUMINIO

YAPC/F



TITANIUM HEEL PROTECTORS
ALETTE PARATACCO IN TITANIUM

YATC/F



	Code - Codice
Brake pressure switch 10*1.25 (L) Interruttore luce freno 10*1.25 (L)	AR25
Brake pressure switch 10*1 (L) Interruttore luce freno 10*1 (L)	AR25B
Brake pressure switch 10*1 (Double L.) Interruttore luce freno 10*1 (Doppia Lungh.)	AR25BD
Brake pressure switch 10*1.25 (Double L.) Interruttore luce freno 10*1.25 (Doppia Lungh.)	AR25D

Brand - Marchio	Model - Modello	Year - Anno	Code - Codice	Leve - Lever			Asta Cam
				Cambio - Shift	Freno - Brake	Cambio Rev. - Reverse Shift	Normal
APRILIA	RS 250	95-02	PEA004NT10A	YL1C0560A	YL1F0562A	YL1C0560A	YASC305
	RSV 1000/TUONO	98-03	PEA001NT10A	YL1C0560A	NO	YL1C0560A	YASC200
	RSV 1000/TUONO	04-08	PEA007NT10A	YL1C0560A	NO	YL1C0560A	YASC170
DUCATI	748/916/996	93-03	PED001NT10A	YL1C0560A	NO	YL1C0560A	YASC210
	MONSTER 1100	09-13	PED016NT10A	YL1C0560A	YL1F0562A	YL1C0560A	YASC205
	MONSTER 696/796	08-15	PED025NT10A	YL1C0560A	YL1F0562A	YL1C0560A	YASC200
	MONSTER S4R/S2R	03-08	PED016NT10A	YL1C0560A	YL1F0562A	YL1C0560A	YASC205
HONDA	CB 1000R	08-17	PEH079NT10A	YL1C0754A	YL1F0565A	YL1C0622A	YASC230
	CBR 1000RR	08-16	PEH073NT10A	YL1C0754A	YL1F0647A	YL1C0754A	YASC235
	CBR 600F	99-06	PEH005NT10A	YL1C0560A	YL1F0564A	YL1C0560A	YASC255
	CBR 600F	11-13	PEH070NT10A	YL1C0754A	YL1F0647A	YL1C0622A	YASC265
	CBR 600RR	03-04	PEH040NT10A	YL1C0754A	YL1F0565A	YL1C0622A	YASC265
	CBR 600RR	05-06	PEH052NT10A	YL1C0754A	YL1F0565A	YL1C0622A	YASC265
	CBR 600RR	07-08	PEH064NT10A	YL1C0754A	YL1F0647A	YL1C0622A	YASC260
	CBR 600RR	09-16	PEH082NT10A	YL1C0560A	YL1F0647A	YL1C0560A	YASC205
	HORNET 600	98-06	PEH020NT10A	YL1C0560A	YL1F0564A	YL1C0560A	YASC245
	HORNET 600	07-13	PEH070NT10A	YL1C0754A	YL1F0565A	YL1C0754A	YASC255
KAWASAKI	ER6N	05-08	PEK046NT10A	YL1C0560A	YL1F0565A	YL1C0560A	YASC275
	ER6N	09-11	PEK080NT10A	YL1C0560A	YL1F0565A	YL1C0560A	YASC275
	VERSYS 650	06-17	PEK046NT10A	YL1C0560A	YL1F0565A	YL1C0560A	YASC275
	Z 1000/SX	10-19	PEK090NT10A	YL1C0560A	YL1F0565A	YL1C0560A	YASC200
	Z 750/1000	07-13	PEK065NT10A	YL1C0560A	YL1F0647A	YL1C0560A	YASC170
	Z 750	03-06	PEK028NT10A	YL1C0560A	YL1F0647A	YL1C0560A	YASC200
	ZX10R	04-05	PEK031NT10A	YL1C0560A	YL1F0647A	YL1C0560A	YASC210
	ZX6R	05-06	PEK040NT10A	YL1C0560A	YL1F0647A	YL1C0560A	YASC215F
	ZX6R	07-08	PEK059NT10A	YL1C0560A	YL1F0647A	YL1C0560A	YASC215F
	ZX6R	09-20	PEK071NT10A	YL1C0560A	YL1F0562A	YL1C0560A	YASC230
	ZX6R/RR/636	95-97	PEK001NT10A	YL1C0560A	YL1F0565A	YL1C0560A	YASC205
	ZX6R/RR/636	98-02	PEK002NT10A	YL1C0560A	YL1F0565A	YL1C0560A	YASC200
	ZX6R/RR/636	03-04	PEK019NT10A	YL1C0560A	YL1F0565A	YL1C0560A	YASC220
	ZX9R	98-05	PEK006NT10A	YL1C0560A	YL1F0565A	YL1C0560A	YASC210
ZZR1400	06-15	PEK068NT10A	YL1C0560A	YL1F0647A	YL1C0560A	YASC230	
SUZUKI	GSR 600	06-12	PES070NT10A	YL1C0754A	YL1F0647A	YL1C0754A	YASC100
	GSR 750	10-16	PES100NT10A	YL1C0560A	YL1F0647A	YL1C0560A	YASC140
	GSXR 1000	01-04	PES023NT10A	YL1C0560A	YL1F0565A	YL1C0560A	YASC190
	GSXR 1000	05-06	PES055NT10A	YL1C0560A	YL1F0565A	YL1C0560A	YASC150
	GSXR 1000	07-08	PES073NT10A	YL1C0560A	YL1F0565A	YL1C0560A	YASC160
	GSXR 1000	09-16	PES082NT10A	YL1C0622A	YL1F0565A	YL1C0754A	YASC225
	GSXR 600	97-00	PES001NT10A	YL1C0560A	YL1F0565A	YL1C0560A	YASC200

Alto - Shift Rod		Plastre - Plate		Rinvio Cambio - Engine Gear		Aluminum Heel Protectors		
	Reverse	Freno - Brake	Cambio - Shift	Normal	Reverse	Cambio - Shift	Freno - Brake	Cambio Rev. - Reverse Shift
	YASC305	YPFF0595	YPFC0596	ORIG	ORIG	N.D.	N.D.	N.D.
	YASC200	YPFF0439	YPFC0440	RP57	RP57	YAPC031	YAPF032	
	YASC170	YPFF0986	YPFC0986A	RP57	RP57	YAPC031	YAPF032	
	YASC210	YPFF0251	YPFC0252	ORIG	ORIG	N.D.	N.D.	
	YASC205	YPFF1169	YPFC1168	ORIG	ORIG	YAPC031	YAPF034	
	YASC160	YPFF1169	YPFC1168	ORIG	ORIG	YAPC031	YAPF034	
	YASC205	YPFF1169	YPFC1168	ORIG	ORIG	YAPC031	YAPF034	
	YASC220	YPFF1306	YPFC1307	RP55	RP55	YAPC031	YAPF024	YAPC039
	YASC235	YPFF1288	YPFC1289	RP47	RP47	YAPC031	YAPF033	
	YASC255	YPFF0097	YPFC0096	ORIG	ORIG	YAPC031	YAPF012	
	YASC235	YPFF1242	YPFC1243	RP47	RP47	YAPC031	YAPF024	YAPC039
	YASC265	YPFF0750A	YPFC0751A	RP47	RP47	YAPC031	YAPF024	YAPC039
	YASC265	YPFF0750	YPFC0751	RP47	RP47	YAPC031	YAPF024	YAPC039
	YASC260	YPFF1214	YPFC1213	RP47	RP47	YAPC031	YAPF024	YAPC039
	YASC205	YPFF1214	YPFC1213	NO	NO	YAPC031	YAPF024	
	YASC245	YPFF0573	YPFC0574	ORIG	ORIG	YAPC031	YAPF012	
	YASC255	YPFF1242	YPFC1243	RP47	RP47	YAPC031	YAPF024	
	YASC275	YPFF1129	YPFC1128	RP59	RP59	YAPC031	YAPF020	
	YASC275	YPFF1341A	YPFC1341	RP59	RP59	YAPC031	YAPF020	
	YASC275	YPFF1129	YPFC1128	RP59	RP59	YAPC031	YAPF020	
	YASC200	YPFF1315A	YPFC1315	RP55	RP55	YAPC031	YAPF027	
	YASC170	YPFF1199	YPFC1200	ORIG	ORIG	YAPC031	YAPF027	
	YASC200	YPFF0991A	YPFC0991	ORIG	ORIG	YAPC040	YAPF027	
	YASC210	YPFF0769A	YPFC0769	ORIG	ORIG	YAPC031	YAPF027	
	YASC215F	YPFF0995A	YPFC0995	ORIG	ORIG	YAPC031	YAPF027	
	YASC215F	YPFF0995A	YPFC0995	ORIG	ORIG	YAPC031	YAPF027	
	YASC230	YPFF1316A	YPFC1316	ORIG	ORIG	YAPC031	YAPF020	
	YASC205	YPFF0254	YPFC0253	ORIG	ORIG	YAPC040	YAPF020	
	YASC200	YPFF0247	YPFC0240	ORIG	ORIG	YAPC040	YAPF020	
	YASC220	YPFF0637	YPFC0638	ORIG	ORIG	YAPC031	YAPF020	
	YASC210	YPFF0247	YPFC0240	ORIG	ORIG	YAPC040	YAPF020	
	YASC230	YPFF1315A	YPFC1315	RP57	RP57	YAPC031	YAPF027	
	YASC100	YPFF1064	YPFC1066	RP58	RP58	YAPC031	YAPF033	
	YASC140	YPFF1404	YPFC1404A	RP58	RP58	YAPC031	YAPF024	
	YASC190	YPFF0410	YPFC0411	ORIG	ORIG	YAPC031	YAPF012	
	YASC150	YPFF1000B	YPFC1000A	ORIG	ORIG	YAPC031	YAPF012	
	YASC160	YPFF1234	YPFC1233	ORIG	ORIG	YAPC031	YAPF024	
	YASC240	YPFF1333	YPFC1333A	RP58	RP58	YAPC039	YAPF024	YAPC031
	YASC200	YPFF0246	YPFC0136	ORIG	ORIG	YAPC031	YAPF024	

Brand - Marchio	Model - Modello	Year - Anno	Code - Codice	Leve - Lever			Asta Cam
				Cambio - Shift	Freno - Brake	Cambio Rev. - Reverse Shift	Normal
	GSXR 600	01-03	PES023NT10A	YL1C0560A	YL1F0565A	YL1C0560A	YASC190
	GSXR 600/750	04-05	PES046NT10A	YL1C0560A	YL1F0565A	YL1C0560A	YASC190
	GSXR 600/750	06-10	PES061NT10A	YL1C0754A	YL1F0565A	YL1C0754A	YASC240F
	GSXR 600/750	11-17	PES094NT10A	YL1C0754A	YL1F0565A	YL1C0754A	YASC230
	GSXR 750	96-99	PES002NT10A	YL1C0560A	YL1F0565A	YL1C0560A	YASC200
	GSXR 750	00-03	PES023NT10A	YL1C0560A	YL1F0565A	YL1C0560A	YASC190
	GSXS 750	17-22	PES100NT10A	YL1C0560A	YL1F0647A	YL1C0560A	YASC140
	RGV250 GAMMA	91-96	PES098NT10A	YL1C0560A	YL1F0562A	YL1C0560A	YASC295
	SV 1000	03-06	PES043NT10A	YL1C0560A	YL1F0647A	YL1C0560A	YASC210F
	SV 650	03-12	PES043NT10A	YL1C0560A	YL1F0647A	YL1C0560A	YASC210F
	SV 650	99-02	PES006NT10A	YL1C0560A	YL1F0565A	YL1C0560A	YASC190
YAMAHA	FAZER 1000	00-05	PEY021NT10A	YL1C0622A	YL1F0565A	YL1C0622A	YASC195
	FZ1	06-15	PEY051NT10A	YL1C0622A	YL1F0647A	YL1C0622A	YASC195S1
	FZ6	04-11	PEY039NT10A	YL1C0622A	YL1F0565A	YL1C0622A	YASC250F
	FZ8	10-16	PEY051NT10A	YL1C0754A	YL1F0647A	YL1C0622A	YASC275
	MT09	13-16	PEY075NT10A	YL1C0754A	YL1F0565A	YL1C0754A	YASC200
	R1	98-01	PEY007NT10A	YL1C0622A	YL1F0562A	YL1C0754A	YASC235
	R1	02-03	PEY024NT10A	YL1C0622A	YL1F0562A	YL1C0754A	YASC245
	R1	04-06	PEY030NT10A	YL1C0622A	YL1F0562A	YL1C0754A	YASC270S2
	R1	07-08	PEY054NT10A	YL1C0622A	YL1F0647A	YL1C0754A	YASC270
	R1	09-14	PEY060NT10A	YL1C0754A	YL1F0565A	YL1C0754A	YASC300
	R6	99-02	PEY006NT10A	YL1C0622A	YL1F0562A	YL1C0754A	YASC305F
	R6	06-16	PEY045NT10A	YL1C0754A	YL1F0562A	YL1C0754A	YASC305
TRIUMPH	DAY/STREET675	06-12	PET008NT10A	YL1C0622A	YL1F0562A	YL1C0622A	YASC200S3
	SPEED TRIPLE	05-10	PET001NT10A	YL1C0560A	YL1F0565A	YL1C0560A	YASC215F
	SPEED TRIPLE	11-15	PET014NT10A	YL1C0560A	YL1F0647A	YL1C0560A	YASC170

Bio - Shift Rod		Piastre - Plate		Rinvio Cambio - Engine Gear		Aluminum Heel Protectors		
Reverse	Freno - Brake	Cambio - Shift	Normal	Reverse	Cambio - Shift	Freno - Brake	Cambio Rev. - Reverse Shift	
YASC190	YPFF0411	YPFC0410	ORIG	ORIG	YAPC031	YAPF012		
YASC190	YPFF0985	YPFC0985A	ORIG	ORIG	YAPC031	YAPF012		
YASC240F	YPFF1106	YPFC1105	ORIG	RP58	YAPC031	YAPF033		
YASC230	YPFF1333	YPFC1333A	RP58	RP58	YAPC031	YAPF024		
YASC200	YPFF0246	YPFC0136	ORIG	ORIG	YAPC031	YAPF024		
YASC190	YPFF0411	YPFC0410	ORIG	ORIG	YAPC031	YAPF012		
YASC140	YPFF1404	YPFC1404A	RP58	RP58	YAPC031	YAPF024		
YASC295	YPFF0976	YPFC0976A	ORIG	ORIG	YAPC031	YAPF030		
YASC210F	YPFF0767	YPFC0768	ORIG	ORIG	YAPC031	YAPF024		
YASC210F	YPFF0767	YPFC0768	ORIG	ORIG	YAPC031	YAPF024		
YASC190	YPFF0246	YPFC0136	ORIG	ORIG	YAPC031	YAPF024		
NO	YPFF0624	YPFC0623	ORIG	ORIG	YAPC039	YAPF027		
YASC245	YPFF1097	YPFC1096	RP55	RP55	YAPC039	YAPF027		
YASC250F	YPFF0987	YPFC0987A	ORIG	ORIG	YAPC039	YAPF020		
YASC245	YPFF1097	YPFC1096	RP55	RP55	YAPC039	YAPF027		
YASC200	YPFF1648	YPFC1648A	ORIG	ORIG	YAPC031	YAPF020		
YASC305	YPFF0630	YPFC0628	ORIG	ORIG	YAPC039	YAPF006	YAPC031	
YASC305	YPFF0621	YPFC0620	ORIG	ORIG	YAPC039	YAPF006	YAPC031	
YASC300	YPFF0630	YPFC0628	ORIG	RP55	YAPC039	YAPF006	YAPC031	
YASC305	YPFF1188	YPFC1189	ORIG	RP55	YAPC039	YAPF027	YAPC031	
YASC300	YPFF1320A	YPFC1320	RP57	RP57	YAPC031	YAPF033		
YASC305F	YPFF0631	YPFC0629	ORIG	ORIG	YAPC039	YAPF006	YAPC031	
YASC305	YPFF1009	YPFC1095	RP57	ORIG	YAPC031	YAPF030		
YASC250	YPFF1124	YPFC1123	ORIG	RP55	YAPC039	YAPF030*		
YASC215F	YPFF0981F	YPFC0981C	ORIG	ORIG	YAPC039	YAPF030*		
YASC170	YPFF1422	YPFC1422A	RP55	RP55	YAPC039	YAPF030*		
						*hole +8mm / foro +8mm		



REARSETS TYPE 1.5

PEDANE TIPO 1.5



ADJUSTABLE TYPE 1.5 REARSETS ARE DEVELOPED FOR STREET/RACING USE, ENTIRELY MADE WITH CNC MACHINERY IN ERGAL 7075 T5 ALLOY. FOOTPEGS AND FRONTPEGS ARE MADE IN ALUMINUM ALLOY MACHINED TO OBTAIN AN OPTIMAL GRIP. SHIFT AND BRAKE LEVERS ARE MOUNTED ON TWO BALL BEARINGS TO AVOID ANY FRICTION. ADJUSTABLE PLATES ALLOWS FROM 6 TO 9 DIFFERENT POSITIONS TO FIND THE BEST FEELING ON THE BIKE. REARSETS ARE PROVIDED WITH BLACK ALUMINUM HEEL PROTECTIONS, THE CORRECT LENGTH SHIFT ROD, SHIFT AND BRAKE BALL JOINTS, BRAKE LIGHT PRESSURE SWITCH. ALL SPARE PARTS ARE AVAILABLE.

LE PEDANE REGOLABILI TIPO 1.5 SONO INTERAMENTE REALIZZATE IN ERGAL 7075 T5 LAVORATO SU CENTRI DI LAVORO CNC ED IL LORO UTILIZZO È CONSIGLIATO PER STRADA E PISTA. I POGGIAPIEDI E I PUNTALINI IN ALLUMINIO SONO LAVORATI PER GARANTIRE UN GRIP OTTIMALE. LE LEVE CAMBIO E FRENO SONO ENTRAMBE MONTATE SU 2 CUSCINETTI A SFERA PER RIDURRE AL MINIMO L'ATTRITO. LE PIASTRE REGOLABILI PERMETTONO DA 6 A 9 POSIZIONI DIVERSE DELLE PEDANE CONSENTENDO DI TROVARE IL MIGLIOR SET-UP PER IL PROPRIO STILE DI GUIDA. IL KIT COMPRENDE LE ALETTE PARATACCO IN ALLUMINIO, TUTTA LA VITERIA NECESSARIA PER IL MONTAGGIO, L'ASTA CAMBIO DELLA CORRETTA LUNGHEZZA, GLI SNODI SFERICI LATO CAMBIO E LATO FRENO E L'INTERRUTTORE A PRESSIONE PER LA LUCE STOP. PER LE PEDANE VMC SONO SEMPRE DISPONIBILI TUTTI I RICAMBI.

SPARE PARTS | TYPE 1.5

RICAMBIO | TIPO 1.5



	Code - Codice
Brake pressure switch 10*1.25 (L) Interruttore luce freno 10*1.25 (L)	AR25
Brake pressure switch 10*1 (L) Interruttore luce freno 10*1 (L)	AR25B
Brake pressure switch 10*1 (Double L.) Interruttore luce freno 10*1 (Doppia Lungh.)	AR25BD
Brake pressure switch 10*1.25 (Double L.) Interruttore luce freno 10*1.25 (Doppia Lungh.)	AR25D



FRONT PEG (SINGLE)
PUNTALINO SINGOLO

RP07S

00
BLACK - NERO



FOOTPEG FOR BEARINGS (SINGLE)
POGGIAPIEDE SINGOLO PER CUSCINETTI

RP48BS

00
BLACK - NERO



FOOTPEG WITH BUSHING (SINGLE)
POGGIAPIEDE SINGOLO CON BRONZINA

RP48S

00
BLACK - NERO



PLASTIC FOOTPEGS PROTECTIONS (PAIR)
TAPPI PROTEZIONE PEDANE (COPPIA)

AR48



Ø6 UNIBALL (MALE) RIGHT
SNODO Ø6 PASSO DESTRO MASCHIO

RP15



Ø6 UNIBALL (MALE) LEFT
SNODO Ø6 PASSO SINISTRO MASCHIO

RP15A



Ø8 UNIBALL (FEMALE)
TESTA A SNODO Ø8 FEMMINA

RP17



TITANIUM HEEL PROTECTORS
ALETTE PARATACCO IN TITANIUM

YATC/F

Brand - Marchio	Model - Modello	Year - Anno	Code - Codice	Leve - Lever			Asta Cambio - Shift Rod	
				Cambio - Shift	Freno - Brake	Cambio Rev. - Reverse Shift	Normal	Reverse
APRILIA	RSV 1000 TUONO	03-10	PEA010NT15A	YL1C0560A	NO	YL1C0560A	YASC170	YASC170
	RSV4/TUONO	09-12	PEA013NT15A	YL1C0560A	YL1F0565A	YL1C0560A	YASC190	YASC190
	RSV4/TUONO APRC	13-16	PEA016NT15A	YL1C0560A	YL1F0565A	YL2C1446A	YASC150	YASC160
	RSV4 RF	17-22	PEA020NT15A	YL1C0560A	YL1F0565A	YL2C1446A	YASC150	YASC160
BMW	F 800	09-14	PEB004NT15A	YL1C0560A	YL1F0562A	YL1C0560A	YASC100	YASC100
	S 1000RR/HP4	09-14	PEB001NT15A	YL1C0622A	YL1F0562A	YL1C0754A	YASC185FM8	YASC195FM8
	S 1000RR	15-18	PEB008NT15A	YL3C1714	YL3F1719	YL3C1714A	NO	NO
	S 1000RR	19-22	PEB011NT15A	YL3C1899	YL3F1863	YL3C1899	NO	NO
DUCATI	1098 / 848 / 1198	07-15	PED022NT15A	YL1C0560A	YL3F1194	YL1C0560A	YASC240F	YASC240F
	999 / 749	03-06	PED019NT15A	YL1C0560A	NO	YL1C0560A	YASC210	YASC210
HONDA	CB 1000R	08-17	PEH091NT15A	YL1C0754A	YL1F0565A	YL1C0622A	YASC230	YASC220
	CBR 1000RR	04-05	PEH047NT15A	YL1C0754A	YL1F0565A	YL1C0622A	YASC240F	YASC240F
	CBR 1000RR	06-07	PEH060NT15A	YL1C0754A	YL1F0565A	YL1C0622A	YASC240F	YASC240F
	CBR 1000RR	08-16	PEH076NT15A	YL1C0754A	YL1F0647A	YL1C0754A	YASC235	YASC235
	CBR 1000RR	17-19	PEH094NT15A	YL3C1732	YL1F0647A	YL3C1732	YASC185	YASC185
	CBR 1000RR	20-22	PEH100NT15A	YL3C1732	YL1F0562A	YL3C1732	YASC100	YASC100
	CBR 1000RR ABS	08-16	PEH076ANT15A	YL1C0754A	YL1F0647A	YL1C0754A	YASC235	YASC235
	CBR 600F	11-13	PEH088NT15A	YL1C0754A	YL1F0647A	YL1C0622A	YASC265	YASC235
	CBR 600RR	03-04	PEH046NT15A	YL1C0754A	YL1F0565A	YL1C0622A	YASC265	YASC265
	CBR 600RR	05-06	PEH055NT15A	YL1C0754A	YL1F0565A	YL1C0622A	YASC265	YASC265
	CBR 600RR	07-08	PEH067NT15A	YL1C0754A	YL1F0647A	YL1C0622A	YASC260	YASC260
	CBR 600RR	09-16	PEH085NT15A	YL1C0560A	YL1F0647A	YL1C0560A	YASC205	YASC205
	CBR 600RR ABS	09-16	PEH085ANT15A	YL1C0560A	YL1F0647A	YL1C0560A	YASC205	YASC205
	CBR 650 R	19-22	PEH097NT15A	YL3C1714A	YL1F0565A	YL3C1714A	YASC170	YASC170
	KAWASAKI	HORNET 600	07-13	PEH088NT15A	YL1C0754A	YL1F0565A	YL1C0754A	YASC255
NINJA 250R/300R		07-17	PEK077NT15A	YL1C0560A	YL1F0565A	YL1C0560A	YASC200	YASC200
NINJA 400		18-22	PEK115NT15A	YL1C0560A	YL1F0562A	YL1C0560A	YASC110	YASC110
Z 1000		07-09	PEK093NT15A	YL1C0560A	YL1F0647A	YL1C0560A	YASC170	YASC170
Z 1000		14-18	PEK100NT15A	YL1C0560A	YL1F0565A	YL1C0560A	YASC160	YASC160
Z 1000/SX		10-19	PEK083NT15A	YL1C0560A	YL1F0565A	YL1C0560A	YASC200	YASC200
Z 650		17-22	PEK112NT15A	YL2C1446A	YL1F0565A	YL1C0560A	YASC170	YASC180
Z 750/R		07-13	PEK093NT15A	YL1C0560A	YL1F0647A	YL1C0560A	YASC170	YASC170
Z 800		13-15	PEK096NT15A	YL1C0560A	YL1F0647A	YL1C0560A	YASC170	YASC170
Z 900		17-22	PEK109NT15A	YL1C0560A	YL1F0562A	YL1C0560A	YASC190	YASC190
ZX10R		06-10	PEK056NT15A	YL1C0560A	YL1F0565A	YL1C0560A	YASC230	YASC230
ZX10R		11-15	PEK087NT15A	YL1C0560A	YL1F0647A	YL1C0560A	YASC235	YASC235
ZX10R		16-22	PEK103NT15A	YL1C0560A	YL3F1450	YL2C1446A	YASC120	YASC095
ZX10R NO USO ABS		16-22	PEK106NT15A	YL1C0560A	YL1F0647A	YL2C1446A	YASC120	YASC095
ZX6R		05-06	PEK043NT15A	YL1C0560A	YL1F0647A	YL1C0560A	YASC215F	YASC215F
ZX6R	07-08	PEK062NT15A	YL1C0560A	YL1F0647A	YL1C0560A	YASC215F	YASC215F	
ZX6R	09-20	PEK074NT15A	YL1C0560A	YL1F0562A	YL1C0560A	YASC230	YASC230	
ZX6R	21-22	PEK108NT15A	YL1C0560A	YL1F0562A	YL1C0560A	YASC230	YASC230	
KTM	SUPERDUKE 1290	14-18	PEO001NT15A	YL1C0560A	YL1F0565A	NO	YASC130	NO

Piastre - Plate		Adattatori - Adapters		Rinvio Cambio - Engine Gear		Aluminum Heel Protectors		
Freno - Brake	Cambio - Shift	Freno - Brake	Cambio - Shift	Normal	Reverse	Cambio - Shift	Freno - Brake	Cambio Rev. - Reverse Shift
YPRF0977	YPRC0977A	YPAF0977B	YPAC0977C	RP57	RP57	YAPC031	YAPF032	YAPC031
YPRF1365	YPRC1365A	YPAF1365B	YPAC1365C	RP47	RP59	YAPC031	YAPF035	YAPC031
YPRF1365	YPRC1365A	YPAF1365B	YPAC1365C	ORIG	ORIG	YAPC031	YAPF035	YAPC047
YPRF1365	YPRC1365A	YPAF1365B	YPAC1365C	ORIG	ORIG	YAPC031	YAPF035	YAPC047
YPRF1399	YPRC1399A	YPAF1369B	YPAC1369C	ORIG	ORIG	YAPC031	YAPF035	YAPC031
YPRF1376	YPRC1376A	YPAF1376B	YPAC1376C	RP84	RP84	YAPC039	YAPF036	YAPC031
YPRF1711A	YPRC1711B	YPAF1711C	YPAC1711D	ORIG	ORIG	YAPC031	YAPF036	YAPC031
YPRF2472D	YPRC2472C	YPAF2472B	YPAC2472A	ORIG	ORIG	YAPC031	YAPF036	YAPC031
YPRF1192	YPRC1193	YPAF1190	YPAC1191	ORIG	ORIG	YAPC031	YAPF032	YAPC031
YPRF1247	YPRC1246	YPAF1248	YPAC1249	ORIG	ORIG	YAPC031	NO	YAPC031
YPRF1424	YPRC1424A	YPAF1424B	YPAC1424C	RP55	RP55	YAPC031	YAPF024	YAPC039
YPRF0972	YPRC0972A	YPAF0972B	YPAC0972C	RP47	RP47	YAPC031	YAPF024	YAPC039
YPRF0972	YPRC0972A	YPAF0972B	YPAC0972C	RP47	RP47	YAPC031	YAPF024	YAPC039
YPRF1291	YPRC1290	YPAF1292	YPAC1293	RP47	RP47	YAPC031	YAPF033	YAPC031
YPRF1604D	YPRC1604A	YPAF1604B	YPAC1604C	RP47	RP47	YAPC031	YAPF024	YAPC031
YPRF2552E	YPRC2552C	YPAF2552B	YPAC2552D	NO	NO	YAPC041	YAPF046	YAPC041
YPRF1487	YPRC1487A	YPAF1487B	YPAC1487C	RP47	RP47	YAPC031	YAPF033	YAPC031
YPRF1409	YPRC1409A	YPAF1409B	YPAC1409C	RP47	RP47	YAPC031	YAPF024	YAPC039
YPRF0973B	YPRC0973C	YPAF0973	YPAC0973A	RP47	RP47	YAPC031	YAPF024	YAPC039
YPRF0973B	YPRC0973C	YPAF0973	YPAC0973A	RP47	RP47	YAPC031	YAPF024	YAPC039
YPRF1222	YPRC1221	YPAF1223	YPAC1224	RP47	RP47	YAPC031	YAPF024	YAPC039
YPRF1222	YPRC1221	YPAF1223	YPAC1224	NO	NO	YAPC031	YAPF024	YAPC031
YPRF1604	YPRC1604A	YPAF1604B	YPAC1604C	NO	NO	YAPC031	YAPF024	YAPC031
YPRF1409	YPRC1409A	YPAF2508B	YPAC2508A	RP47	RP47	YAPC031	YAPF024	YAPC031
YPRF1409	YPRC1409A	YPAF1409B	YPAC1409C	RP47	RP47	NO	NO	NO
YPRF1314A	YPRC1314	YPAF1314B	YPAC1314C	ORIG	ORIG	YAPC031	YAPF027	YAPC031
YPRF2385B	YPRC2385D	YPAF2385A	YPAC2385C	RP55	RP91	YAPC031	YAPF027	YAPC031
YPRF1448	YPRC1448A	YPAF1448B	YPAC1448C	ORIG	ORIG	YAPC040	YAPF027	YAPC040
YPRF1672A	YPRC1672B	YPAF1672C	YPAC1672D	ORIG	ORIG	YAPC031	YAPF027	YAPC031
YPRF1315A	YPRC1315	YPAF1382	YPAC1382A	RP55	RP55	YAPC031	YAPF027	YAPC031
YPRF1945B	YPRC1945A	YPAF1945D	YPAC1945C	ORIG	ORIG	NO	YAPF027	YAPC031
YPRF1448	YPRC1448A	YPAF1448B	YPAC1448C	ORIG	ORIG	YAPC040	YAPF027	YAPC040
YPRF1479	YPRC1479A	YPAF1479B	YPAC1479C	ORIG	ORIG	YAPC031	YAPF038	YAPC031
YPRF1956B	YPRC1956A	YPAF1956D	YPAC1956C	ORIG	RP89	YAPC031	YAPF027	YAPC031
YPRF1106	YPRC1106A	YPAF1106C	YPAC1106B	ORIG	ORIG	YAPC031	YAPF027	YAPC031
YPRF1405	YPRC1405A	YPAF1405B	YPAC1405C	RP59	RP59	YAPC031	YAPF027	YAPC031
YPRF1450A	YPRC1450B	YPAF1450C	YPAC1450D	RP59	RP59	YAPC031	YAPF032	YAPC031
YPRF1405	YPRC1405A	YPAF1405B	YPAC1405C	RP59	RP59	YAPC031	YAPF032	YAPC031
YPRF0996C	YPRC0996B	YPAF0996	YPAC0996A	ORIG	ORIG	YAPC031	YAPF027	YAPC031
YPRF0996C	YPRC0996B	YPAF0996	YPAC0996A	ORIG	ORIG	YAPC031	YAPF027	YAPC031
YPRF1317A	YPRC1317	YPAF1317B	YPAC1317C	ORIG	ORIG	YAPC031	YAPF020	YAPC031
YPRF1317A	YPRC1317	YPAF1317B	YPAC1317C	ORIG	ORIG	YAPC031	YAPF020	YAPC031
YPRF2345A	YPRC2345B	YPAF2345C	YPAC2345D	ORIG	NO	YAPC041	YAPF035	NO

Brand - Marchio	Model - Modello	Year - Anno	Code - Codice	Leve - Lever			Asta Cambio - Shift Rod	
				Cambio - Shift	Freno - Brake	Cambio Rov. - Reverse Shift	Normal	Reverse
SUZUKI	B KING	07-12	PES088NT15A	YL1C0560A	YL1F0647A	YL1C0560A	YASC170	YASC170
	GLADIUS 650	09-15	PES091NT15A	YL1C0560A	YL1F0647A	YL1C0560A	YASC220F	YASC220F
	GSR 750	10-16	PES103NT15A	YL1C0560A	YL1F0647A	YL1C0560A	YASC140	YASC140
	GSR 1000	01-04	PES049NT15A	YL1C0560A	YL1F0565A	YL1C0560A	YASC190	YASC190
	GSR 1000	05-06	PES058NT15A	YL1C0560A	YL1F0565A	YL1C0560A	YASC150	YASC150
	GSR 1000	07-08	PES076NT15A	YL1C0560A	YL1F0565A	YL1C0560A	YASC160	YASC160
	GSR 1000	09-16	PES085NT15A	YL1C0622A	YL1F0565A	YL1C0754A	YASC225	YASC240
	GSR 1000	17-12	PES112NT15A	YL3C1732A	YL1F0565A	YL3C1732A	YASC180	YASC180
	GSR 1300	08-17	PES079NT15A	YL1C0560A	YL1F0647A	YL1C0560A	YASC170	YASC170
	GSR 600/750	00-03	PES049NT15A	YL1C0560A	YL1F0565A	YL1C0560A	YASC190	YASC190
	GSR 600/750	04-05	PES050NT15A	YL1C0560A	YL1F0565A	YL1C0560A	YASC190	YASC190
	GSR 600/750	06-10	PES064NT15A	YL1C0754A	YL1F0565A	YL1C0754A	YASC240F	YASC240F
	GSR 600/750	11-17	PES095NT15A	YL1C0754A	YL1F0565A	YL1C0754A	YASC230	YASC230
	GSXS 1000	15-22	PES106NT15A	YL1C0560A	YL1F0565A	YL1C0560A	YASC150	YASC170
	GSXS 750	17-22	PES103NT15A	YL1C0560A	YL1F0647A	YL1C0560A	YASC140	YASC140
	SV650	16-22	PES109NT15A	YL1C0560A	YL1F0647A	YL1C0560A	YASC170	YASC170
	YAMAHA	FZ1	06-15	PEY072NT15A	YL1C0622A	YL1F0647A	YL1C0622A	YASC195
FZ8		10-16	PEY072NT15A	YL1C0754A	YL1F0647A	YL1C0622A	YASC275	YASC245
MT07		14-17	PEY079NT15A	YL1C0754A	YL1F0647A	YL1C0754A	YASC230	YASC230
MT09		13-16	PEY076NT15A	YL1C0754A	YL1F0565A	YL1C0754A	YASC200	YASC200
MT09		17-22	PEY094NT15A	YL1C0754A	YL1F0565A	NO	YASC110	NO
MT10		16-22	PEY088NT15A	YL3C1899	YL1F0647A	YL3C1899	NO	NO
R 125		08-18	PEY069NT15A	YL1C0560A	YL1F0562A	YL1C0560A	YASC275	YASC275
R1		04-06	PEY034NT15A	YL1C0622A	YL1F0562A	YL1C0754A	YASC270S2	YASC300
R1		98-01	PEY042NT15A	YL1C0622A	YL1F0562A	YL1C0754A	YASC235	YASC305
R1		07-08	PEY057NT15A	YL1C0622A	YL1F0647A	YL1C0754A	YASC270	YASC305
R1		09-14	PEY063NT15A	YL1C0754A	YL1F0565A	YL1C0754A	YASC300	YASC300
R1		15-22	PEY082NT15A	YL3C1732	YL1F0647A	YL3C1732A	YASC095	YASC095
R3		15-22	PEY085NT15A	YL1C0560A	YL1F0565A	YL1C0560A	YASC170	YASC180
R6		03-05	PEY033NT15A	YL1C0622A	YL1F0562A	YL1C0754A	YASC305F	YASC305
R6		06-16	PEY048NT15A	YL1C0754A	YL1F0562A	YL1C0754A	YASC305	YASC305
R6	17-22	PEY091NT15A	YL3C1899	YL1F0562A	YL3C1899	YASC110	YASC110	
XJ6	09-15	PEY066NT15A	YL1C0754A	YL1F0565A	YL1C0754A	YASC275	YASC275	
TRIUMPH	DAYTONA 675	06-12	PET011NT15A	YL1C0622A	YL1F0562A	YL1C0622A	YASC200S3	YASC250
	DAYTONA 675	13-16	PET023NT15A	YL1C0622A	YL1F0562A	YL1C0622A	YASC110	YASC120
	SPEED TRIPLE	05-10	PET004NT15A	YL1C0560A	YL1F0565A	YL1C0560A	YASC215F	YASC215F
	SPEED TRIPLE	11-15	PET017NT15A	YL1C0560A	YL1F0647A	YL1C0560A	YASC170	YASC170
	STREET TRIPLE	07-12	PET011NT15A	YL1C0622A	YL1F0562A	YL1C0622A	YASC200S3	YASC250
STREET TRIPLE	13-16	PET020NT15A	YL1C0622A	YL1F0562A	YL1C0622A	YASC200	YASC250	

Piastre - Plate		Adattatori - Adapters		Rinvio Cambio - Engine Gear		Aluminum Heel Protectors		
Freno - Brake	Cambio - Shift	Freno - Brake	Cambio - Shift	Normal	Reverse	Cambio - Shift	Freno - Brake	Cambio Rov. - Reverse Shift
YPRF1313A	YPRC1313	YPAF1313C	YPAC1313B	ORIG	ORIG	YAPC031	YAPF033	YAPC031
YPRF1375	YPRC1375A	YPAF1375B	YPAC1375C	RP58	RP58	NO	NO	NO
YPRF1313A	YPRC1313	YPAF1313C	YPAC1313B	RP58	RP58	YAPC031	YAPF023	YAPC031
YPRF0990C	YPRC0990B	YPAF0990	YPAC0990A	ORIG	ORIG	YAPC031	YAPF012	YAPC031
YPRF0998	YPRC0998A	YPAF0998B	YPAC0998C	ORIG	ORIG	YAPC031	YAPF012	YAPC031
YPRF1234	YPRC1233	YPAF1236	YPAC1235	ORIG	ORIG	YAPC031	YAPF024	YAPC031
YPRF1333	YPRC1333A	YPAF1115	YPAC1116	RP58	RP58	YAPC039	YAPF024	YAPC031
YPRF1973A	YPRC1973	YPAF1973C	YPAC1973B	ORIG	ORIG	YAPC031	YAPF024	YAPC031
YPRF1313A	YPRC1313	YPAF1313C	YPAC1313B	ORIG	RP58	YAPC031	YAPF023	YAPC031
YPRF0990C	YPRC0990B	YPAF0990	YPAC0990A	ORIG	ORIG	YAPC031	YAPF012	YAPC031
YPRF1059	YPRC1061	YPAF1060	YPAC1062	ORIG	ORIG	YAPC031	YAPF012	YAPC031
YPRF1106	YPRC1105	YPAF1115	YPAC1116	ORIG	RP58	YAPC031	YAPF033	YAPC031
YPRF1333	YPRC1333A	YPAF1115	YPAC1116	RP58	RP58	YAPC031	YAPF024	YAPC031
YPRF1744B	YPRC1744A	YPAF1744C	YPAC1744D	ORIG	ORIG	YAPC031	YAPF012	YAPC031
YPRF1313A	YPRC1313	YPAF1313C	YPAC1313B	RP58	RP58	YAPC031	YAPF023	YAPC031
YPRF1845A	YPRC1845B	YPAF1845C	YPAC1845D	ORIG	ORIG	YAPC031	YAPF033	YAPC031
YPRF1401	YPRC1401A	YPAF1401B	YPAC1401C	RP55	RP55	YAPC040	YAPF027	YAPC039
YPRF1401	YPRC1401A	YPAF1401B	YPAC1401C	RP55	RP55	YAPC031	YAPF027	YAPC039
YPRF1683	YPRC1683A	YPAF1683B	YPAC1683C	ORIG	ORIG	YAPC031	YAPF027	YAPC031
YPRF1648	YPRC1648A	YPAF1648B	YPAC1648C	ORIG	ORIG	YAPC031	YAPF020	YAPC031
YPRF1648	YPRC1648A	YPAF1648B	YPAC1648C	ORIG	NO	YAPC031	YAPF020	YAPC031
YPRF1879A	YPRC1879B	YPAF1879C	YPAC1879D	ORIG	ORIG	YAPC041	YAPF020	YAPC041
YPRF1372	YPRC1372A	YPAF1372B	YPAC1372C	RP47	RP55	YAPC031	YAPF036	YAPC031
YPRF0975	YPRC0975A	YPAF0975B	YPAC0975C	ORIG	RP55	YAPC039	YAPF006	YAPC031
YPRF0975	YPRC0975A	YPAF0975B	YPAC0975C	ORIG	ORIG	YAPC039	YAPF006	YAPC031
YPRF1185	YPRC1184	YPAF1183	YPAC1182	ORIG	RP55	YAPC039	YAPF027	YAPC031
YPRF1319A	YPRC1319	YPAF1319B	YPAC1319C	RP57	RP57	YAPC031	YAPF033	YAPC031
YPRF1723A	YPRC1723B	YPAF1723D	YPAC1723C	ORIG	ORIG	YAPC041	YAPF042	YAPC041
YPRF1742B	YPRC1742A	YPAF1742C	YPAC1742D	ORIG	RP91	YAPC031	YAPF027	YAPC031
YPRF1216	YPRC1215	YPAF1217	YPAC1218	ORIG	ORIG	YAPC039	YAPF006	YAPC031
YPRF1090	YPRC1008	YPAF1091	YPAC1092	RP57	ORIG	YAPC031	YAPF030	YAPC031
YPRF1971B	YPRC1972B	YPAF1971A	YPAC1972A	RP57	RP57	YAPC031	YAPF030	YAPC031
YPRF1362	YPRC1362A	YPAF1362B	YPAC1362C	RP47	RP47	YAPC031	YAPF027	YAPC031
YPRF1047	YPRC1046	YPAF1045	YPAC1044	ORIG	RP55	YAPC039	YAPF030	YAPC039
YPRF1047	YPRC1046	YPAF1045	YPAC1044	ORIG	RP55	YAPC039	YAPF030	YAPC039
YPRF1087	YPRC1011	YPAF1089	YPAC1088	ORIG	ORIG	YAPC031	YAPF027	YAPC031
YPRF1413	YPRC1413A	YPAF1413B	YPAC1413C	RP55	RP55	YAPC031	YAPF027	YAPC031
YPRF1047	YPRC1046	YPAF1045	YPAC1044	ORIG	RP55	YAPC039	YAPF030	YAPC039
YPRF1047	YPRC1046	YPAF1045	YPAC1044	ORIG	RP55	YAPC039	YAPF030	YAPC039



REARSETS TYPE 2.5

PEDANE TIPO 2.5



ADJUSTABLE TYPE 2.5 REARSETS ARE DEVELOPED MAINLY FOR STREET USE, ARE ENTIRELY MADE WITH CNC MACHINERY IN ERGAL 7075 T5 ALLOY AND ARE THE ONLY ONE MODEL AVAILABLE IN FOUR DIFFERENT COLORS. FOOTPEGS AND FRONTPEGS ARE MADE IN ALUMINUM ALLOY COVERED BY RUBBER PADS TO OFFER A BETTER COMFORT. SHIFT AND BRAKE LEVERS ARE MOUNTED ON TWO BALL BEARINGS TO AVOID ANY FRICTION. SHIFT FRONTPEG IS 10 MM ADJUSTABLE. DRILLED PLATES ALLOWS FROM 6 TO 9 DIFFERENT POSITIONS TO FIND THE BEST FEELING ON THE BIKE. REARSETS ARE PROVIDED WITH STAINLESS STEEL HEEL PROTECTIONS, CORRECT LENGTH SHIFT ROD, SHIFT AND BRAKE BALL JOINTS, BRAKE LIGHT PRESSURE SWITCH. ALL SPARE PARTS ARE AVAILABLE.

LE PEDANE REGOLABILI TIPO 2.5 SONO INTERAMENTE REALIZZATE IN ERGAL 7075 T5 LAVORATO SU CENTRI DI LAVORO CNC E SONO CONSIGLIATE PER USO STRADALE. I POGGIAPIEDI E I PUNTALINI IN ALLUMINIO SONO RICOPERTI IN GOMMA PER MIGLIORARE SENSIBILMENTE IL COMFORT. LE LEVE CAMBIO E FRENO SONO ENTRAMBE MONTATE SU 2 CUSCINETTI A SFERA PER RIDURRE AL MINIMO L'ATTRITO. LA LEVA CAMBIO PERMETTE LA REGOLAZIONE DEL PINTALINO DI 10 MM. LE PIASTRE REGOLABILI PERMETTONO DA 6 A 9 POSIZIONI DIVERSE DELLE PEDANE CONSENTENDO DI TROVARE IL MIGLIOR SET-UP PER IL PROPRIO STILE DI GUIDA. IL KIT COMPRENDE LE ALETTE PARATACCO IN ACCIAIO INOX, TUTTA LA VITERIA NECESSARIA PER IL MONTAGGIO, L'ASTA CAMBIO DELLA CORRETTA LUNGHEZZA, GLI SNODI SFERICI LATO CAMBIO E LATO FRENO E L'INTERRUTTORE A PRESSIONE PER LA LUCE STOP. PER LE PEDANE VMC SONO SEMPRE DISPONIBILI TUTTI I RICAMBI.

00	02	03	04
BLACK - NERO	BLUE - BLU	GOLD - ORO	RED - ROSSO



Brake pressure switch 10*1.25 (L)
Interruttore luce freno 10*1.25 (L)

Code - Codice

AR25

Brake pressure switch 10*1 (L)
Interruttore luce freno 10*1 (L)

AR25B

Brake pressure switch 10*1 (Double L.)
Interruttore luce freno 10*1 (Doppia Lungh.)

AR25BD

Brake pressure switch 10*1.25 (Double L.)
Interruttore luce freno 10*1.25 (Doppia Lungh.)

AR25D



FRONT PEG WITH RUBBER (SINGLE)
POGGIAPIEDE SINGOLO COMPLETO DI GOMMINO

RP34S



RUBBER PADS (PAIR)
COPPIA GOMMINI PER PUNTALINI

RP35



FOOTPEG WITH BUSHING (LEFT)
POGGIAPIEDE SINISTRO CON BRONZINA

RP70LS

00
BLACK - NERO



FOOTPEG WITH BUSHING (RIGHT)
POGGIAPIEDE DESTRO CON BRONZINA

RP70RS

00
BLACK - NERO



FOOTPEG FOR BEARINGS (LEFT)
POGGIAPIEDE SINISTRO PER CUSCINETTI

RP70BLS

00
BLACK - NERO



FOOTPEG FOR BEARINGS (RIGHT)
POGGIAPIEDE DESTRO PER CUSCINETTI

RP70BRS

00
BLACK - NERO

SPARE PARTS | TYPE 2.5

RICAMBIO | TIPO 2.5



RUBBER PARTS FOOTPEGS (PAIR)
COPPIA INSERTO GOMMA PER POGGIPIEDE

RP72



Ø6 UNIBALL (MALE) RIGHT
SNODO Ø6 PASSO DESTRO MASCHIO

RP15



Ø6 UNIBALL (MALE) LEFT
SNODO Ø6 PASSO SINISTRO MASCHIO

RP15A



Ø8 UNIBALL (FEMALE)
TESTA A SNODO Ø8 FEMMINA

RP17

OPTIONAL



TITANIUM HEEL PROTECTORS
ALETTE PARATACCO IN TITANIUM

YATC/F

Brand - Marchio	Model - Modello	Year - Anno	Code - Codice	Leve - Lever			Asta Cambio - Shift Rod	
				Cambio - Shift	Freno - Brake	Cambio Rev. - Reverse Shift	Normal	Reverse
APRILIA	RSV 1000 TUONO	03-10	PEA011NT25A	YL2C0090A	NO	YL2C0090A	YASC170	YASC170
	RSV4/TUONO	09-12	PEA014NT25A	YL2C0090A	YL2F0121A	YL2C0090A	YASC190	YASC190
	RSV4/TUONO APRC	13-16	PEA017NT25A	YL2C0090A	YL2F0121A	YL2C1446A	YASC150	YASC160
	RSV4 RF	17-22	PEA021NT15A	YL2C0090A	YL2F0121A	YL2C1446A	YASC150	YASC160
BMW	F 800	09-14	PEB005NT25A	YL2C0090A	YL2F0034A	YL2C0090A	YASC100	YASC100
	S1000RR/HP4	09-14	PEB002NT25A	YL2C0625A	YL2F0034A	YL2C0755A	YASC185FM8	YASC195FM8
	S1000RR	15-18	PEB009NT25A	YL3C1714	YL3F1719	YL3C1714A	NO	NO
	S 1000RR	19-22	PEB012NT25A	YL3C1899	YL3F1719	YL3C1899	NO	NO
DUCATI	1098/B48/1198	07-15	PED023NT25A	YL2C0090A	YL3F1194	YL2C0090A	YASC240F	YASC240F
	999/749	03-06	PED020NT25A	YL2C0090A	NO	YL2C0090A	YASC210	YASC210
HONDA	CB 1000R	08-17	PEH092NT25A	YL2C0755A	YL2F0121A	YL2C0625A	YASC230	YASC220
	CBR 1000RR	04-05	PEH049NT25A	YL2C0755A	YL2F0121A	YL2C0625A	YASC240F	YASC240F
	CBR 1000RR	06-07	PEH061NT25A	YL2C0755A	YL2F0121A	YL2C0625A	YASC240F	YASC240F
	CBR 1000RR	08-16	PEH077NT25A	YL2C0755A	YL2F0648A	YL2C0755A	YASC235	YASC235
	CBR 1000RR	17-19	PEH095NT25A	YL3C1732	YL2F0648A	YL3C1732	YASC185	YASC185
	CBR 1000RR	20-21	PEH101NT25A	YL3C1732	YL2F0034A	YL3C1732	YASC100	YASC100
	CBR 1000RR ABS	08-16	PEH077ANT25A	YL2C0755A	YL2F0648A	YL2C0755A	YASC235	YASC235
	CBR 600F	11-13	PEH089NT25A	YL2C0755A	YL2F0648A	YL2C0625A	YASC265	YASC235
	CBR 600RR	03-04	PEH048NT25A	YL2C0755A	YL2F0121A	YL2C0625A	YASC265	YASC265
	CBR 600RR	05-06	PEH056NT25A	YL2C0755A	YL2F0121A	YL2C0625A	YASC265	YASC265
	CBR 600RR	07-08	PEH068NT25A	YL2C0755A	YL2F0648A	YL2C0625A	YASC260	YASC260
	CBR 600RR	09-16	PEH086NT25A	YL2C0090A	YL2F0648A	YL2C0090A	YASC205	YASC205
	CBR 600RR ABS	09-16	PEH086ANT25A	YL2C0090A	YL2F0648A	YL2C0090A	YASC205	YASC205
	CBR 650 R	19-22	PEH098NT25A	YL3C1714A	YL2F0121A	YL3C1714A	YASC170	YASC170
	HORNET 600	07-13	PEH089NT25A	YL2C0755A	YL2F0121A	YL2C0755A	YASC255	YASC255
	NINJA 250R/300R	07-17	PEK078NT25A	YL2C0090A	YL2F0121A	YL2C0090A	YASC200	YASC200
KAWASAKI	NINJA 400	18-22	PEK116NT25A	YL2C0090A	YL2F0034A	YL2C0090A	YASC110	YASC110
	Z 1000	07-09	PEK094NT25A	YL2C0090A	YL2F0648A	YL2C0090A	YASC170	YASC170
	Z 1000	14-18	PEK101NT25A	YL2C0090A	YL2F0121A	YL2C0090A	YASC160	YASC160
	Z 1000/SX	10-19	PEK084NT25A	YL2C0090A	YL2F0121A	YL2C0090A	YASC200	YASC200
	Z 650	17-18	PEK113NT25A	YL2R1446A	YL2F0121A	YL2C0090A	YASC170	YASC180
	Z 750/R	07-13	PEK094NT25A	YL2C0090A	YL2F0648A	YL2C0090A	YASC170	YASC170
	Z 800	13-15	PEK097NT25A**	YL2C0090A	YL2F0648A	YL2C0090A	YASC170	YASC170
	Z 900	17-22	PEK110NT25A	YL2C0090A	YL2F0034A	YL2C0090A	YASC190	YASC190
	ZX10R	06-10	PEK057NT25A	YL2C0090A	YL2F0121A	YL2C0090A	YASC230	YASC230
	ZX10R	11-15	PEK088NT25A	YL2C0090A	YL2F0648A	YL2C0090A	YASC235	YASC235
	ZX10R	16-22	PEK104NT25A	YL2C0090A	YL3F1450	YL2C1446A	YASC120	YASC095
	ZX10R NO USO ABS	16-22	PEK107NT25A	YL2C0090A	YL2F0648A	YL2C1446A	YASC120	YASC095
	ZX6R	05-06	PEK044NT25A	YL2C0090A	YL2F0648A	YL2C0090A	YASC215F	YASC215F
	ZX6R	07-08	PEK063NT25A	YL2C0090A	YL2F0648A	YL2C0090A	YASC215F	YASC215F
	ZX6R	09-20	PEK075NT25A	YL2C0090A	YL2F0034A	YL2C0090A	YASC230	YASC230
	ZX6R	21-22	PEK119NT25A	YL2C0090A	YL2F0034A	YL2C0090A	YASC230	YASC230
KTM	SUPERDUKE 1290	14-18	PEO002NT25A	YL2C0090A	YL2F0121A	NO	YASC130	NO

Plastre - Plate		Adattatori - Adapters		Rinvio Cambio - Engine Gear		Aluminum Heel Protectors		
Freno - Brake	Cambio - Shift	Freno - Brake	Cambio - Shift	Normal	Reverse	Cambio - Shift	Freno - Brake	Cambio Rev. - Reverse Shift
YPRF0977	YPRC0977A	YPAF0977B	YPAC0977C	RP57	RP57	YAPC031	YAPF032	YAPC031
YPRF1365	YPRC1365A	YPAF1365B	YPAC1365C	RP47	RP59	YAPC031	YAPF035	YAPC031
YPRF1365	YPRC1365A	YPAF1365B	YPAC1365C	ORIG	ORIG	YAPC031	YAPF035	YAPC047
YPRF1365	YPRC1365A	YPAF1365B	YPAC1365C	ORIG	ORIG	YAPC031	YAPF035	YAPC047
YPRF1399	YPRC1399A	YPAF1369B	YPAC1369C	ORIG	ORIG	YAPC031	YAPF035	YAPC031
YPRF1376	YPRC1376A	YPAF1376B	YPAC1376C	RP84	RP84	YAPC039	YAPF036	YAPC031
YPRF1711A	YPRC1711B	YPAF1711C	YPAC1711D	ORIG	ORIG	YAPC031	YAPF036	YAPC031
YPRF2472D	YPRC2472C	YPAF2472B	YPAC2472A	ORIG	ORIG	YAPC031	YAPF036	YAPC031
YPRF1192	YPRC1193	YPAF1190	YPAC1191	ORIG	ORIG	YAPC031	YAPF032	YAPC031
YPRF1247	YPRC1246	YPAF1248	YPAC1249	ORIG	ORIG	YAPC031	NO	YAPC031
YPRF1424	YPRC1424A	YPAF1424B	YPAC1424C	RP55	RP55	YAPC031	YAPF024	YAPC039
YPRF0972	YPRC0972A	YPAF0972B	YPAC0972C	RP47	RP47	YAPC031	YAPF024	YAPC039
YPRF0972	YPRC0972A	YPAF0972B	YPAC0972C	RP47	RP47	YAPC031	YAPF024	YAPC039
YPRF1291	YPRC1290	YPAF1292	YPAC1293	RP47	RP47	YAPC031	YAPF033	YAPC031
YPRF1604D	YPRC1604A	YPAF1604B	YPAC1604C	RP47	RP47	YAPC031	YAPF024	YAPC031
YPRF2552C	YPRC2552E	YPAF2552B	YPAC2552D	NO	NO	YAPC041	YAPF046	YAPC041
YPRF1487	YPRC1487A	YPAF1487B	YPAC1487C	RP47	RP47	YAPC031	YAPF033	YAPC031
YPRF1409	YPRC1409A	YPAF1409B	YPAC1409C	RP47	RP47	YAPC031	YAPF024	YAPC039
YPRF0973B	YPRC0973C	YPAF0973	YPAC0973A	RP47	RP47	YAPC031	YAPF024	YAPC039
YPRF0973B	YPRC0973C	YPAF0973	YPAC0973A	RP47	RP47	YAPC031	YAPF024	YAPC039
YPRF1222	YPRC1221	YPAF1223	YPAC1224	RP47	RP47	YAPC031	YAPF024	YAPC039
YPRF1222	YPRC1221	YPAF1223	YPAC1224	NO	NO	YAPC031	YAPF024	YAPC031
YPRF1604	YPRC1604A	YPAF1604B	YPAC1604C	NO	NO	YAPC031	YAPF024	YAPC031
YPRF1409	YPRC1409A	YPAF2508B	YPAC2508A	RP47	RP47	YAPC031	YAPF024	YAPC031
YPRF1409	YPRC1409A	YPAF1409B	YPAC1409C	RP47	RP47	NO	NO	NO
YPRF1314A	YPRC1314	YPAF1314B	YPAC1314C	ORIG	ORIG	YAPC031	YAPF027	YAPC031
YPRF2385B	YPRC2385D	YPAF2385A	YPAC2385C	RP55	RP55	YAPC031	YAPF027	YAPC031
YPRF1448	YPRC1448A	YPAF1448B	YPAC1448C	ORIG	ORIG	YAPC040	YAPF027	YAPC040
YPRF1672A	YPRC1672B	YPAF1672C	YPAC1672D	ORIG	ORIG	YAPC031	YAPF027	YAPC031
YPRF1315A	YPRC1315	YPAF1382	YPAC1382A	RP55	RP55	YAPC031	YAPF027	YAPC031
YPRF1945B	YPRC1945A	YPAF1945D	YPAC1945C	ORIG	ORIG	YAPC031	YAPF027	YAPC031
YPRF1448	YPRC1448A	YPAF1448B	YPAC1448C	ORIG	ORIG	YAPC040	YAPF027	YAPC040
YPRF1479	YPRC1479A	YPAF1479B	YPAC1479C	ORIG	ORIG	YAPC031	YAPF038	YAPC031
YPRF1956B	YPRC1956A	YPAF1956D	YPAC1956C	ORIG	RP89	YAPC031	YAPF027	YAPC031
YPRF1106	YPRC1106A	YPAF1106C	YPAC1106B	ORIG	ORIG	YAPC031	YAPF027	YAPC031
YPRF1405	YPRC1405A	YPAF1405B	YPAC1405C	RP59	RP59	YAPC031	YAPF027	YAPC031
YPRF1450A	YPRC1450B	YPAF1450C	YPAC1450D	RP59	RP59	YAPC031	YAPF032	YAPC031
YPRF1405	YPRC1405A	YPAF1405C	YPAC1405B	RP59	RP59	YAPC031	YAPF032	YAPC031
YPRF0996C	YPRC0996B	YPAF0996	YPAC0996A	ORIG	ORIG	YAPC031	YAPF027	YAPC031
YPRF0996C	YPRC0996B	YPAF0996	YPAC0996A	ORIG	ORIG	YAPC031	YAPF027	YAPC031
YPRF1317A	YPRC1317	YPAF1317B	YPAC1317C	ORIG	ORIG	YAPC031	YAPF020	YAPC031
YPRF1317A	YPRC1317	YPAF1317B	YPAC1317C	ORIG	ORIG	YAPC031	YAPF020	YAPC031
YPRF2345A	YPRC2345B	YPAF2345C	YPAC2345D	ORIG	NO	YAPC041	YAPF035	NO

Brand - Marchio	Model - Modello	Year - Anno	Code - Codice	Leve - Lever			Asta Cambio - Shift Rod	
				Cambio - Shift	Freno - Brake	Cambio Rov. - Reverse Shift	Normal	Reverse
SUZUKI	B KING	07-12	PES089NT25A	YL2C0090A	YL2F0648A	YL2C0090A	YASC170	YASC170
	GLADIUS 650	09-15	PES092NT25A	YL2C0090A	YL2F0648A	YL2C0090A	YASC220F	YASC220F
	GSR 750	10-16	PES104NT25A	YL2C0090A	YL2F0648A	YL2C0090A	YASC140	YASC140
	GSXR 1000	01-04	PES051NT25A	YL2C0090A	YL2F0121A	YL2C0090A	YASC190	YASC190
	GSXR 1000	05-06	PES059NT25A	YL2C0090A	YL2F0121A	YL2C0090A	YASC150	YASC150
	GSXR 1000	07-08	PES077NT25A	YL2C0090A	YL2F0121A	YL2C0090A	YASC160	YASC160
	GSXR 1000	09-16	PES086NT25A	YL2C0625A	YL2F0121A	YL2C0755A	YASC225	YASC240
	GSXR 1000	17-12	PES113NT25A	YL3C1732A	YL2F0121A	YL3C1732A	YASC180	YASC180
	GSXR 1300	08-17	PES080NT25A	YL2C0090A	YL2F0648A	YL2C0090A	YASC170	YASC170
	GSXR 600/750	00-03	PES051NT25A	YL2C0090A	YL2F0121A	YL2C0090A	YASC190	YASC190
	GSXR 600/750	04-05	PES052NT25A	YL2C0090A	YL2F0121A	YL2C0090A	YASC190	YASC190
	GSXR 600/750	06-10	PES065NT25A	YL2C0755A	YL2F0121A	YL2C0755A	YASC240F	YASC240F
	GSXR 600/750	11-17	PES096NT25A	YL2C0755A	YL2F0121A	YL2C0755A	YASC230	YASC230
	GSXS 1000	15-22	PES107NT25A	YL2C0090A	YL2F0121A	YL2C0090A	YASC150	YASC170
	GSXS 750	17-22	PES104NT25A	YL2C0090A	YL2F0648A	YL2C0090A	YASC140	YASC140
	SV650	16-22	PES110NT25A	YL2C0090A	YL2F0648A	YL2C0090A	YASC170	YASC170
	YAMAHA	FZ1	06-15	PEY073NT25A	YL2C0625A	YL2F0648A	YL2C0625A	YASC195
FZ8		10-16	PEY073NT25A	YL2C0755A	YL2F0648A	YL2C0625A	YASC275	YASC245
MT07		14-17	PEY080NT25A	YL2C0755A	YL2F0648A	YL2C0755A	YASC230	YASC230
MT09		13-16	PEY077NT25A	YL2C0755A	YL2F0121A	YL2C0755A	YASC200	YASC200
MT09		17-22	PEY095NT25A	YL2C0755A	YL2F0121A	NO	YASC110	NO
MT10		16-22	PEY089NT25A	YL3C1899	YL2F0648A	YL3C1870	NO	NO
R 125		08-18	PEY070NT25A	YL2C0090A	YL2F0034A	YL2C0090A	YASC275	YASC275
R1		04-06	PEY036NT25A	YL2C0625A	YL2F0034A	YL2C0755A	YASC27052	YASC300
R1		98-01	PEY043NT25A	YL2C0625A	YL2F0034A	YL2C0755A	YASC235	YASC305
R1		07-08	PEY058NT25A	YL2C0625A	YL2F0648A	YL2C0755A	YASC270	YASC305
R1		09-14	PEY064NT25A	YL2C0755A	YL2F0121A	YL2C0755A	YASC300	YASC300
R1		15-22	PEY083NT25A	YL3C1732*	YL2F0648A	YL3C1732A	YASC095	YASC095
R3		15-22	PEY086NT25A	YL2C0090A	YL2F0121A	YL2C0090A	YASC170	YASC180
R6		03-05	PEY035NT25A	YL2C0625A	YL2F0034A	YL2C0755A	YASC305F	YASC305
R6	06-16	PEY049NT25A	YL2C0755A	YL2F0034A	YL2C0755A	YASC305	YASC305	
R6	17-22	PEY092NT25A	YL3C1732*	YL2F0034A	YL3C1732A	YASC110	YASC110	
XJ6	09-15	PEY067NT25A	YL2C0755A	YL2F0121A	YL2C0755A	YASC275	YASC275	
TRIUMPH	DAYTONA 675	06-12	PET012NT25A	YL2C0625A	YL2F0034A	YL2C0625A	YASC20053	YASC250
	DAYTONA 675	13-16	PET024NT25A	YL2C0625A	YL2F0034A	YL2C0625A	YASC110	YASC120
	SPEED TRIPLE	05-10	PET005NT25A	YL2C0090A	YL2F0121A	YL2C0090A	YASC215F	YASC215F
	SPEED TRIPLE	11-15	PET018NT25A	YL2C0090A	YL2F0648A	YL2C0090A	YASC170	YASC170
	STREET TRIPLE	07-12	PET012NT25A	YL2C0625A	YL2F0034A	YL2C0625A	YASC20053	YASC250
STREET TRIPLE	13-16	PET021NT25A	YL2C0625A	YL2F0034A	YL2C0625A	YASC200	YASC250	

Piastre - Plate		Adattatori - Adapters		Rinvio Cambio - Engine Gear		Aluminum Heel Protectors		
Freno - Brake	Cambio - Shift	Freno - Brake	Cambio - Shift	Normal	Reverse	Cambio - Shift	Freno - Brake	Cambio Rev. - Reverse Shift
YPRF1313A	YPRC1313	YPAF1313C	YPAC1313B	ORIG	ORIG	YAPC031	YAPF033	YAPC031
YPRF1375	YPRC1375A	YPAF1375B	YPAC1375C	RP58	RP58	NO	NO	NO
YPRF1313A	YPRC1313	YPAF1313C	YPAC1313B	RP58	RP58	YAPC031	YAPF023	YAPC031
YPRF0990C	YPRC0990B	YPAF0990	YPAC0990A	ORIG	ORIG	YAPC031	YAPF012	YAPC031
YPRF0998	YPRC0998A	YPAF0998B	YPAC0998C	ORIG	ORIG	YAPC031	YAPF012	YAPC031
YPRF1234	YPRC1233	YPAF1236	YPAC1235	ORIG	ORIG	YAPC031	YAPF024	YAPC031
YPRF1333	YPRC1333A	YPAF1115	YPAC1116	RP58	RP58	YAPC039	YAPF024	YAPC031
YPRF1973A	YPRC1973	YPAF1973C	YPAC1973B	ORIG	ORIG	YAPC031	YAPF024	YAPC031
YPRF1313A	YPRC1313	YPAF1313C	YPAC1313B	ORIG	RP58	YAPC031	YAPF023	YAPC031
YPRF0990C	YPRC0990B	YPAF0990	YPAC0990A	ORIG	ORIG	YAPC031	YAPF012	YAPC031
YPRF1059	YPRC1061	YPAF1060	YPAC1062	ORIG	ORIG	YAPC031	YAPF012	YAPC031
YPRF1106	YPRC1105	YPAF1115	YPAC1116	ORIG	RP58	YAPC031	YAPF033	YAPC031
YPRF1333	YPRC1333A	YPAF1115	YPAC1116	RP58	RP58	YAPC031	YAPF024	YAPC031
YPRF1744B	YPRC1744A	YPAF1744C	YPAC1744D	ORIG	ORIG	YAPC031	YAPF012	YAPC031
YPRF1313A	YPRC1313	YPAF1313C	YPAC1313B	RP58	RP58	YAPC031	YAPF023	YAPC031
YPRF1845A	YPRC1845B	YPAF1845C	YPAC1845D	ORIG	ORIG	YAPC031	YAPF023	YAPC031
YPRF1401	YPRC1401A	YPAF1401B	YPAC1401C	RP55	RP55	YAPC040	YAPF027	YAPC039
YPRF1401	YPRC1401A	YPAF1401B	YPAC1401C	RP55	RP55	YAPC031	YAPF027	YAPC039
YPRF1683	YPRC1683A	YPAF1683B	YPAC1683C	ORIG	ORIG	YAPC031	YAPF027	YAPC031
YPRF1648	YPRC1648A	YPAF1648B	YPAC1648C	ORIG	ORIG	YAPC031	YAPF020	YAPC031
YPRF1648	YPRC1648A	YPAF1648B	YPAC1648C	ORIG	NO	YAPC031	YAPF020	YAPC031
YPRF1879A	YPRC1879B	YPAF1879C	YPAC1879D	ORIG	ORIG	YAPC041	YAPF020	YAPC041
YPRF1372	YPRC1372A	YPAF1372B	YPAC1372C	RP47	RP55	YAPC031	YAPF036	YAPC031
YPRF0975	YPRC0975A	YPAF0975B	YPAC0975C	ORIG	RP55	YAPC039	YAPF006	YAPC031
YPRF0975	YPRC0975A	YPAF0975B	YPAC0975C	ORIG	ORIG	YAPC039	YAPF006	YAPC031
YPRF1185	YPRC1184	YPAF1183	YPAC1182	ORIG	RP55	YAPC039	YAPF027	YAPC031
YPRF1319A	YPRC1319	YPAF1319B	YPAC1319C	RP57	RP57	YAPC031	YAPF033	YAPC031
YPRF1723A	YPRC1723B	YPAF1723D	YPAC1723C	ORIG	ORIG	YAPC041	YAPF042	YAPC041
YPRF1742B	YPRC1742A	YPAF1742C	YPAC1742D	ORIG	RP91	YAPC031	YAPF027	YAPC031
YPRF1216	YPRC1215	YPAF1217	YPAC1218	ORIG	ORIG	YAPC039	YAPF006	YAPC031
YPRF1090	YPRC1008	YPAF1091	YPAC1092	RP57	ORIG	YAPC031	YAPF030	YAPC031
YPRF1971B	YPRC1972B	YPAF1971A	YPAC1972A	RP57	RP57	YAPC031	YAPF030	YAPC031
YPRF1362	YPRC1362A	YPAF1362B	YPAC1362C	RP47	RP47	YAPC031	YAPF027	YAPC031
YPRF1047	YPRC1046	YPAF1045	YPAC1044	ORIG	RP55	YAPC039	YAPF030	YAPC039
YPRF1047	YPRC1046	YPAF1045	YPAC1044	ORIG	RP55	YAPC039	YAPF030	YAPC039
YPRF1087	YPRC1011	YPAF1089	YPAC1088	ORIG	ORIG	YAPC031	YAPF027	YAPC031
YPRF1413	YPRC1413A	YPAF1413B	YPAC1413C	RP55	RP55	YAPC031	YAPF027	YAPC031
YPRF1047	YPRC1046	YPAF1045	YPAC1044	ORIG	RP55	YAPC039	YAPF030	YAPC039
YPRF1047	YPRC1046	YPAF1045	YPAC1044	ORIG	RP55	YAPC039	YAPF030	YAPC039

Model - Modello	Year - Anno	Code - Codice	Code - Codice	Code - Codice
		TYPE 1	TYPE 1.5	TYPE 2.5
APRILIA				
RS 250	95-02	PEA004NT10A		
RSV 1000	98-03	PEA001NT10A***		
RSV 1000	04-08	PEA007NT10A***	PEA010NT15A	PEA011NT25A
RSV4 / R	09-12		PEA013NT15A	PEA014NT25A
	09-12 reverse shift		PEA013RT15A	PEA014RT25A
RSV4 / R	13-16		PEA016NT15A	PEA017NT25A
	13-16 reverse shift		PEA016RT15A	PEA017RT25A
RSV4 RF	17-22		PEA020NT15A	PEA021NT25A
	17-22 reverse shift		PEA020RT15A	PEA021RT25A
TUONO 1000	03-10		PEA010NT15A	PEA011NT25A
	09-12		PEA013NT15A	PEA014NT25A
	13-16		PEA016NT15A	PEA017NT25A
BMW				
S 1000 RR / HP4	09-14		PEB001NT15A	PEB002NT25A
S 1000 RR / HP4	09-14 reverse shift		PEB001RT15A	PEB002RT25A
S 1000 RR	15-18		PEB008NT15A	PEB009NT25A
	15-18 reverse shift		PEB008RT15A	PEB009RT25A
S 1000 RR	19-22		PEB011NT15A	PEB012NT15A
F 800 R	09-14		PEB004NT15A	PEB005NT25A
DUCATI				
748 / 916 / 996	93-03	PED001NT10A***		
749 / 999	03-06		PED019NT15A***	PED020NT25A***
848 / 1098 / 1198	07-15		PED022NT15A***	PED023NT25A
MONSTER 696 / 796	08-15	PED025NT10A**		
MONSTER S4R / S2R	03-08	PED016NT10A		
MONSTER 1100	09-13	PED016NT10A		
HONDA				

Model - Modello	Year - Anno	Code - Codice	Code - Codice	Code - Codice
CBR 600 F	99-06	PEH005NT10A		
	11-13	PEH070NT10A*	PEH088NT15A**	PEH089NT25A**
	11-13 reverse shift		PEH088RT15A**	PEH089RT25A**
CBR 600 R / RR	03-04	PEH040NT10A	PEH046NT15A	PEH048NT25A
	03-04 reverse shift	PEH040RT10A	PEH046RT15A	PEH048RT25A
	05-06	PEH052NT10A	PEH055NT15A	PEH056NT25A
	05-06 reverse shift	PEH052RT10A	PEH055RT15A	PEH056RT25A
	07-08	PEH064NT10A	PEH067NT15A	PEH068NT25A
	07-08 reverse shift	PEH064RT10A	PEH067RT15A	PEH068RT25A
	09-16	PEH082NT10A	PEH085NT15A	PEH086NT25A
	09-16/ABS		PEH085ANT15A	PEH086ANT25A
CBR 650 R	19-22		PEH097NT15A	PEH098NT25A
CBR 1000 R / RR	04-05		PEH047NT15A	PEH049NT25A
	04-05 reverse shift		PEH047RT15A	PEH049RT25A
	06-07		PEH060NT15A	PEH061NT25A
	06-07 reverse shift		PEH060RT15A	PEH061RT25A
	08-16	PEH073NT10A	PEH076NT15A	PEH077NT25A
	08-16/ABS		PEH076ANT15A	PEH077ANT25A
CBR 1000 RR	17-19		PEH094NT15A	PEH095NT25A
	20-22		PEH100NT15A	PEH101NT25A
HORNET 600	98-06	PEH020NT10A**		
	07-13	PEH070NT10A*	PEH088NT15A**	PEH089NT25A**
	07-13 reverse shift		PEH088RT15A**	PEH089RT25A**
CB 1000 R / ABS	08-17	PEH079NT10A	PEH091NT15A	PEH092NT25A
KAWASAKI				
NINJA 250 R	07-13		PEK077NT15A	PEK078NT25A
NINJA 300 R	12-17		PEK077NT15A	PEK078NT25A
NINJA 400	18-22		PEK115NT15A	PEK116NT25A
ZX 6-636 R / RR	95-97	PEK001NT10A		

Model - Modello	Year - Anno	Code - Codice	Code - Codice	Code - Codice
	98-02	PEK002NT10A		
	03-04	PEK019NT10A		
	05-06	PEK040NT10A	PEK043NT15A	PEK044NT25A
	07-08	PEK059NT10A	PEK062NT15A	PEK063NT25A
ZX 6-636 R / RR / ABS	09-20	PEK071NT10A	PEK074NT15A	PEK075NT25A
	21-22		PEK118NT15A	PEK119NT25A
ZX 9 R	98-05	PEK006NT10A		
ZX 10 R	04-05	PEK031NT10A		
	06-10		PEK056NT15A	PEK057NT25A
ZX 10 R (NO ABS)	11-15		PEK087NT15A	PEK088NT25A
	16-22		PEK106NT15A	PEK107NT25A
	16-22 reverse shift		PEK106RT15A	PEK107RT25A
ZX 10 R /ABS	16-22		PEK103NT15A	PEK104NT25A
	16-22 reverse shift		PEK103RT15A	PEK104RT25A
ZZR 1400 R	06-15	PEK068NT10A		
VERSYS 650	06-17	PEK046NT10A**		
ER 6N	05-08	PEK046NT10A**		
	09-11	PEK080NT10A**		
(kit passenger)	05-11	PEP02		
Z 650	17-22		PEK112NT15A	PEK113NT25A
	17-22 reverse shift		PEK112RT15A	PEK113RT12A
Z 750 / R	03-06	PEK028NT10A		
Z 750 / R / ABS	07-13	PEK065NT10A	PEK093NT15A	PEK094NT25A
Z 800 / R / ABS	13-15		PEK096NT15A**	PEK097NT25A**
(kit passenger)	13-15	PEP03		
Z 900 ABS	17-22		PEK109NT15A	PEK110NT25A
	17-22 reverse shift		PEK109RT15A	PEK110RT25A
Z 1000	07-09	PEK065NT10A	PEK093NT15A	PEK094NT25A
Z1000 /ABS	10-13	PEK090NT10A	PEK083NT15A	PEK084NT25A

Model - Modello	Year - Anno	Code - Codice	Code - Codice	Code - Codice
	14-18		PEK100NT15A	PEK101NT25A
Z 1000 SX / ABS	10-19	PEK090NT10A	PEK083NT15A	PEK084NT25A
KTM				
SUPERDUKE 1290	14-18		PEO001NT15A	PEO002NT25A
SUZUKI				
RGV 250 GAMMA	91-96	PES098NT10A		
GSX 600 R	97-00	PES001NT10A		
	01-03	PES023NT10A	PES049NT15A	PES051NT25A
GSX 750 R	96-99	PES002NT10A		
	00-03	PES023NT10A	PES049NT15A	PES051NT25A
GSX 600 / 750 R	04-05	PES046NT10A	PES050NT15A	PES052NT25A
	06-10	PES061NT10A	PES064NT15A	PES065NT25A
	06-10 reverse shift	PES061RT10A	PES064RT15A	PES065RT25A
	11-17	PES094NT10A	PES095NT15A	PES096NT25A
GSX 1000 R	01-04	PES023NT10A	PES049NT15A	PES051NT25A
	05-06	PES055NT10A	PES058NT15A	PES059NT25A
	07-08	PES073NT10A	PES076NT15A	PES077NT25A
GSX 1000 R (NO ABS)	09-16	PES082NT10A	PES085NT15A	PES086NT25A
	09-16 reverse shift	PES082RT10A	PES085RT15A	PES086RT25A
	17-22		PES112NT15A	PES113NT25A
GSX 1300R HAYABUSA	08-17		PES079NT15A	PES080NT25A
	08-17 reverse shift		PES079RT15A	PES080RT25A
GSR 600	06-12	PES070NT10A**		
(kit passenger)	06-12	PEP01		
SV 650 / S	99-02	PES006NT10A		
	03-12	PES043NT10A		
SV 650 ABS	16-22		PES109NT15A	PES110NT25A
GLADIUS 650	09-15		PES091NT15A**	PES092NT25A**
(kit passenger)	09-15	PEP04		

Model - Modello	Year - Anno	Code - Codice	Code - Codice	Code - Codice
GSR 750	10-16	PES100NT10A	PES103NT15A	PES104NT25A
GSX -S750	17-22	PES100NT10A	PES103NT15A	PES104NT25A
GSX -S1000 -950	15-22		PES106NT15A	PES107NT25A
	15-22 reverse shift		PES106RT15A	PES107RT25A
SV 1000 / S	03-06	PES043NT10A		
B-KING	07-12		PES088NT15A	PES089NT25A
YAMAHA				
R125	08-18		PEY069NT15A	PEY070NT25A
	08-18 reverse shift		PEY069RT15A	PEY070RT25A
R3	15-22		PEY085NT15A	PEY086NT25A
	15-22 reverse shift		PEY085RT15A	PEY086RT25A
R6	99-02	PEY006NT10A		
	99-02 reverse shift	PEY006RT10A		
	03-05		PEY033NT15A	PEY035NT25A
	03-05 reverse shift		PEY033RT15A	PEY035RT25A
	06-16	PEY045NT10A	PEY048NT15A	PEY049NT25A
	06-16 reverse shift	PEY045RT10A	PEY048RT15A	PEY049RT25A
	17-22		PEY091NT15A	PEY092NT25A
R1	98-01	PEY007NT10A	PEY042NT15A	PEY043NT25A
	98-01 reverse shift	PEY007RT10A	PEY042RT15A	PEY043RT25A
	02-03	PEY024NT10A		
	02-03 reverse shift	PEY024RT10A		
	04-06	PEY030NT10A	PEY034NT15A	PEY036NT25A
	04-06 reverse shift	PEY030RT10A	PEY034RT15A	PEY036RT25A
	07-08	PEY054NT10A	PEY057NT15A	PEY058NT25A
	07-08 reverse shift	PEY054RT10A	PEY057RT15A	PEY058RT25A
	09-14	PEY060NT10A	PEY063NT15A	PEY064NT25A
	15-22		PEY082NT15A	PEY083NT25A
	15-22 reverse shift		PEY082RT15A	PEY083RT25A
FAZER 1000	00-05	PEY021NT10A		
XJ6	09-15		PEY066NT15A **	PEY067NT25A **

Model - Modello	Year - Anno	Code - Codice	Code - Codice	Code - Codice
(kit passenger)	09-15	PEP03		
FZ6	04-11	PEY039NT10A		
FZ8	10-16	PEY051NT10A	PEY072NT15A	PEY073NT25A
	10-16 reverse shift	PEY051RT10A	PEY072RT15A	PEY073RT25A
FZ1	06-15	PEY051NT10A	PEY072NT15A	PEY073NT25A
	06-15 reverse shift	PEY051RT10A	PEY072RT15A	PEY073RT25A
MT 07 / ABS	14-17		PEY079NT15A	PEY080NT25A
MT 09 / ABS	13-16	PEY075NT10A	PEY076NT15A	PEY077NT25A
	17-22		PEY094NT15A	PEY095NT25A
MT10	16-22		PEY088NT15A	PEY089NT25A
TRIUMPH				
DAYTONA 675 / R	06-12	PET008NT10A	PET011NT15A	PET012NT25A
	06-12 reverse shift	PET008RT10A	PET011RT15A	PET012RT25A
	13-16		PET023NT15A	PET024NT25A
	13-16 reverse shift		PET023RT15A	PET024RT25A
STREET TRIPLE / R	07-12	PET008NT10A	PET011NT15A	PET012NT25A
	07-12 reverse shift	PET008RT10A	PET011RT15A	PET012RT25A
	13-16		PET020NT15A	PET021NT25A
	13-16 reverse shift		PET020RT15A	PET021RT25A
SPEED TRIPLE / R	05-10	PET001NT10A	PET004NT15A	PET005NT25A
	11-15	PET014NT10A	PET017NT15A	PET018NT25A



* PASSENGER ENCLOSED
* PASSEGGERO INCLUSO

** PASSENGER EXCLUDED
** PASSEGGERO ESCLUSO

*** REARSETS WITHOUT BRAKE LEVER
*** PEDANE SENZA LEVA FRENO



FOOTPEGS WITH LED

POGGIAPIEDE LED



LEFT FOOTPEGS WITH LED
POGGIAPIEDE SINISTRO CON LED

RIGHT FOOTPEGS WITH LED
POGGIAPIEDE DESTRO CON LED

THE FOOTREST DESIGN COMES DIRECTLY FROM THE MODEL ADOPTED FOR THE TOP RANGE OF VMC REARSETS AND AT THE MOMENT CAN BE USED EXCLUSIVELY ON THE VMC REARSETS. THE FOOTREST IS MADE OF CNC MACHINED ALUMINUM. INSIDE THERE IS A HIGH BRIGHTNESS LIGHTING CIRCUIT WITH MICRO LEDS, PROTECTED BY A TRANSPARENT RED COVER. THIS DEVICE ALLOWS BOTH POSITION LIGHT FUNCTION AND BRIGHTER STOP FUNCTION.

POGGIAPIEDI CHE DERIVA DIRETTAMENTE DAL MODELLO ADOTTATO PER LE PEDANE PEDANE VMC. IL POGGIAPIEDI È REALIZZATO IN ALLUMINIO LAVORATO CNC. ALL'INTERNO DEI POGGIAPIEDI È INSERITO UN CIRCUITO DI ILLUMINAZIONE A MICRO LED AD ALTA LUMINOSITÀ PROTETTO DA UNA COVER TRASPARENTE DI COLORE ROSSO. QUESTO DISPOSITIVO COMPRENDE SIA LA FUNZIONE DI LUCE DI POSIZIONE CHE QUELLA PIÙ LUMINOSA DELLO STOP.

ORIGINAL REARSETS ADJUSTERS

PIASTRE ARRETRAMENTO



REARSETS ADJUSTER KIT ALLOWS TO CHANGE ORIGINAL REARSETS POSITION TILL 25/30 MM REAR AND HIGH BY 2/4 DIFFERENT SET-UP POINTS TO FIND THE BEST FEELING. ENTIRELY MADE WITH CNC MACHINERY IN ERGAL 7075 T5 ALLOY ARE PROVIDED WITH A SHIFT ROD EXTENSION TO AVOID ANY MODIFY DURING ASSEMBLY. THEY ARE AVAILABLE ONLY IN BLACK COLOR.

LE PIASTRE DI ARRETRAMENTO PEDANE ORIGINALI VMC HANNO UNA PREDISPOSIZIONE DI 2-4 POSIZIONI CHE PERMETTONO DI ARRETRARE ED ALZARE LE PEDANE DI 25/30 MM PER OTTENERE UN MIGLIOR FEELING CON I COMANDI. LE PIASTRE SONO INTERAMENTE RICAVATE DAL PIENO IN ERGAL 7075 E VENGONO LAVORATE CON CENTRI DI LAVORO A CONTROLLO NUMERICO CNC. INSIEME ALLE PIASTRE VIENE FORNITA UNA PROLUNGA PER L'ASTA CAMBIO ORIGINALE PER EVITARE CHE DEBBA ESSERE SOSTITUITA. DISPONIBILI SOLO NEL COLORE NERO.

00
BLACK - NERO

Model - Modello	Year - Anno	Code - Codice
HONDA		
CBR 600 F	99-06	PAPH01
KAWASAKI		
NINJA 250 R	07-13	PAPK09
NINJA 300 R	12-17	PAPK09
ZX 6-636 R / NO ABS	05-17	PAPK08
ZX 10 R	06-10	PAPK07
ZX 10 R / NO ABS	11-15	PAPK10
SUZUKI		
GSX 600 R	01-05	PAPS01
GSX 750 R	00-05	PAPS01
GSXS 750	17-19	PAPS06
GSX 1000 R	01-04	PAPS01
	05-06	PAPS05
GSX 1300R HAYABUSA	08-17	PAPS06
SV650 / S	99-02	PAPS01
GSR 750	10-16	PAPS06
B-KING	07-12	PAPS06
YAMAHA		
R6	03-05	PAPY03
R1	99-03	PAPY02
	04-06	PAPY04
	07-08	PAPY05

SPARE PARTS



SHAFT EXTENDER
PROLUNGA ASTA CAMBIO

RP46



SHIFT ROD ADAPTER LEFT THREAD
ADATTATORE ASTE CAMBIO FILETTO SX

RP86L



SHIFT ROD ADAPTER RIGHT THREAD
ADATTATORE ASTE CAMBIO FILETTO DX

RP86R

FOLD UP FOOTPEGS



FOLD UP FOOTPEGS

POGGIAPIEDI



FOLD UP FOOTPEGS
POGGIAPIEDI

POGGIAPIEDI ALLEGGERITI IN ALLUMINIO LAVORATI DAL PIENO CON MACCHINARI CNC. LA SUPERFICIE DI APPOGGIO È STATA LAVORATA PER GARANTIRE UN OTTIMO GRIP MENTRE IL DESIGN OFFRE UN LOOK MAGGIORMENTE RACING ALLA MOTO. DISPONIBILI PER IL CONDUCENTE O PER IL PASSEGGERO.

LIGHT WEIGHT FOOTPEGS ENTIRELY MADE WITH CNC MACHINERY IN ALUMINUM ALLOY DEVELOPED TO OFFER A GOOD GRIP GIVING A RACING LOOK TO THE BIKE. AVAILABLE FOR RIDER AND PASSENGER.

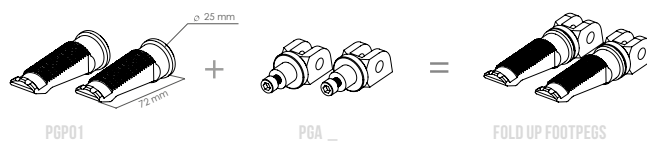

00	02	03	04	05	07	16
BLACK - NERO	BLUE - BLU	GOLD - ORO	RED - ROSSO	TITANIUM	GREEN - VERDE	ORANGE - ARANCIONE



ADAPTERS



Model - Modello	Year - Anno	Code - Codice	Code - Codice
		Driver	Passenger
BMW			
F 800 R	09-14	PGA10	PGA60
DUCATI			
DIAVEL	11-18	PGA14	
HONDA			
CBR 600 F	11-13	PGA02	PGA51
CBR 600 R / RR / ABS	03-16	PGA01	PGA51
CBR 650 R	19-22	PGA02	PGA67
CBR 1000 R / RR	04-16	PGA01	PGA51
	17-18	PGA02	PGA67
AFRICA TWIN	17-19		PGA51
HORNET 600	07-13	PGA02	PGA51
CB 650 R	19-22	PGA02	PGA67
CB 1000 R / ABS	08-17	PGA01	PGA51
KAWASAKI			
NINJA 400	18-20	PGA04	PGA53
ZX 6-636 R / RR / ABS	05-17	PGA03	PGA53
ZX 10 R	06-10	PGA03	PGA53
ZX 10 R / ABS	11-18	PGA11	PGA53
Z 1000 SX	10-18	PGA05	PGA53
ER6N	05-08	PGA04	PGA53
	09-11	PGA05	PGA53
Z 650	17-22	PGA05	PGA53
Z 750 / R / ABS	03-13	PGA05	PGA53
Z 800 / R / ABS	13-16	PGA05	PGA53
Z 900	17-22	PGA05	PGA53
Z 1000	03-09	PGA05	PGA53
	10-18	PGA04	PGA53
MV AGUSTA			
F3	11-22	PGA16	PGA16
F4	13-16	PGA16	PGA16
TURISMO VELOCE	14-22	PGA16	PGA16

Model - Modello	Year - Anno	Code - Codice	Code - Codice
B3	11-22	PGA16	PGA16
DRAGSTER	14-22	PGA16	PGA16
RIVALE	13-18	PGA16	PGA16
STRADALE	15-16	PGA16	PGA16
BRUTALE 1000	19-22	PGA16	
SUZUKI			
GSX 600 / 750 R	06-17	PGA06	PGA56
GSX 1000 R	05-22	PGA06	PGA56
V STROM 1000	16-19	PGA06	
GSX -S125	17-22	PGA06	PGA71
GSR 600	06-11	PGA06	PGA56
GLADIUS 650	09-15	PGA06	PGA56
SV 650 ABS	16-18	PGA06	PGA56
GSR 750	11-16	PGA06	PGA56
GSX -S750	17-20	PGA06	PGA56
GSX -S1000 -950	15-22	PGA06	PGA56
B-KING	07-12	PGA06	PGA56
YAMAHA			
R6	03-22	PGA07	PGA57
R1	02-22	PGA07	PGA57
XJ6	09-15	PGA08	PGA58
FZ6	04-11	PGA08	PGA58
FZ8	10-16	PGA08	PGA59
FZ1	06-15	PGA07	PGA59
MT07 / ABS	14-17	PGA08	PGA58
MT09 / ABS	13-16	PGA13	PGA58
	17-21	PGA13	PGA70
MT10	16-22	PGA07	PGA58
T-MAX	08-15		PGA58
TRIUMPH			
DAYTONA 675	06-16	PGA12	PGA62
STREET TRIPLE / R	07-19	PGA12	PGA62
SPEED TRIPLE / R	11-15	PGA12	PGA62

STAND



'PRO' STEEL STAND

CAVALLETTO ACCIAIO 'PRO'



'Pro' Fork rear stand steel
CAVALLETTO POSTERIORE A FORCHETTA ACCIAIO 'Pro'

AR50A

VMC PRO LINE STEEL BOXED FRAME STAND IS ENTIRELY MADE FROM A STEEL SHEET BENT AND HANDCRAFTED WELDED. IS EQUIPPED WITH TWO RED/BLACK LARGE WHEELS VMC DESIGNED. IT CAN BE USED WITH ALL KIND OF STAND SPOOLS.

IL CAVALLETTO CON TELAIO SCATOLATO DELLA LINEA PRO LINE È INTERAMENTE REALIZZATO DA UN UNICO FOGLIO DI ACCIAIO PIEGATO E SALDATO ARTIGIANALMENTE. È EQUIPAGGIATO CON 2 RUOTE BICOMPONENTI NERO/ROSSO REALIZZATE IN ESCLUSIVA PER VMC.



PRO' FRONT STAND STEEL RADICAL CALIPERS
CAVALLETTO ANTERIORE PER PINZE RADIALI ACCIAIO 'PRO'

AR53A



PRO' ENDURANCE REAR STAND STEEL
CAVALLETTO POSTERIORE ENDURANCE ACCIAIO 'PRO'

AR55A

SPARE PARTS



FORK REAR ADAPTERS (2 PAIR)
ADATTATORI A FORCHETTA (2 COPPIE)

ADCA23



ENDURANCE ADAPTERS FOR 'PRO' STAND
ADATTATORI ENDURANCE PER CAVALLETTI 'PRO'

ADCA24



WHEEL SPIGOT FOR 'PRO' STANDS
PERNO RUOTA PER CAVALLETTI 'PRO'

RP80

'RACE' STEEL STAND

CAVALLETTO ACCIAIO 'RACE'



'RACE' FRONT STAND
CAVALLETTO ANTERIORE 'RACE'

CAV0310

'RACE' STAND IS THE MOST POPULAR OF THE ENTIRE VMC STANDS LINE. IT IS MADE WITH STRONG STEEL AND PAINTED WITH A SPECIAL EMBOSSED LONG LIFE POWDER COATING. IS EQUIPPED WITH TWO RED/BLACK LARGE WHEELS VMC DESIGNED. IT CAN BE USED WITH ALL KIND OF STAND SPOOLS AND THE WIDTH CAN BE MANUALLY ADJUSTED TO FIT WITH ALL RACING BIKES.

IL CAVALLETTO 'RACE' È INDUBBIAMENTE QUELLO PIÙ POPOLARE DELLA LINEA DI CAVALLETTI VMC. È REALIZZATO IN TUBI DI ACCIAIO RESISTENTE SALDATI A MANO E COLORATI CON VERNICIATURA EPOSSIDICA GOFFRATA PER DURARE NEL TEMPO. È EQUIPAGGIATO CON 2 RUOTE NERO/ROSSO REALIZZATE IN ESCLUSIVA PER VMC. PUÒ ESSERE UTILIZZATO CON TUTTI I MODELLI DI SUPPORTI CAVALLETTO E LA LARGHEZZA È REGOLABILE MANUALMENTE PER L'UTILIZZO SU TUTTE LE MOTO.



FRONT STAND RADICAL CALIPERS 'RACE'
CAVALLETTO ANTERIORE PER PINZE RADIALI 'RACE'

CAV0310MV1



RACE[!] FORK REAR STAND
CAVALLETTO POSTERIORE A FORCHETTA 'RACE'

CAV0110



RACE[!] ENDURANCE REAR STAND
CAVALLETTO POSTERIORE ENDURANCE 'RACE'

CAV2110

SPARE PARTS



RED-BLACK WHELL FOR STANDS 'RACE-PRO'
RUOTA ROSSO-NERA PER CAVALLETTI 'RACE-PRO'

RP79 04



FRONT CALIPERS STAND REPLACEMENT
POMOLI RICAMBIO CAVALLETTI PER PINZE RADIALI

RP90

'STREET' STEEL STAND

CAVALLETTO ACCIAIO 'STREET'



'STREET' FORK REAR STAND
CAVALLETTO POSTERIORE A FORCHETTA 'STREET'

CAVS0119

'STREET' STAND IS THE BEST SELLER OF THE ENTIRE VMC STANDS LINE. IT IS MADE WITH STRONG STEEL AND PAINTED WITH A SPECIAL MATT POWDER COATING. IT IS EQUIPPED WITH TWO RED/BLACK LARGE WHEELS. IT CAN BE USED WITH ALL KIND OF STAND SPOOLS AND THE WIDTH CAN BE MANUALLY ADJUSTED TO FIT WITH ALL RACING BIKES.

IL CAVALLETTO 'STREET' È IL PIÙ VENDUTO DELL'INTERA LINEA DI CAVALLETTI VMC. È REALIZZATO IN ACCIAIO RINFORZATO E COLORATO CON UNA SPECIALE VERNICE A POLVERE. È EQUIPAGGIATO CON 2 RUOTE ROSSO/NERO DI GRANDI DIMENSIONI. LE FORCHETTE PERMETTONO L'UTILIZZO DI QUESTO CAVALLETTO CON TUTTI I MODELLI DI SUPPORTI CAVALLETTO E LA LARGHEZZA È REGOLABILE MANUALMENTE PER ADATTARSI AL FORCELLONE DI OGNI MOTO.



"STREET" FRONT STAND
CAVALLETTO ANTERIORE "STREET"

CAVS0319



REAR ADJUSTABLE STAND
CAVALLETTO POSTERIORE REGOLABILE "STREET"

CAVS0519

SPARE PARTS



FORK ADAPTER (PAIR)
ADATTATORI A FORCHETTA (COPPIA)

ADCA1710



PLATE ADAPTER (PAIR)
COPPIA ADATTATORI A SLITTA (COPPIA)

ADCA1810



WHEEL FOR "STREET" STANDS
RUOTA PER CAVALLETTI "STREET"

RP7719 04

TRANSPORT STAND

CAVALLETTO PER TRASPORTO



TRANSPORT STAND
CAVALLETTO PER TRASPORTO

CAV20

VMC TRANSPORT STAND IS NECESSARY TO EASILY CARRY THE BIKE ON THE VAN. IS MADE IN HARD STEEL AND CAN BE FIXED IN A VAN OR IN OTHER PLACES BY FOUR BOLTS HOLES ON THE BOTTOM. BY A TILTING SYSTEM IT'S EASY TO HOLD AND RELEASE THE FRONT WHEEL OF THE BIKE. AVAILABLE ONLY IN BLACK COLOR.

IL CAVALLETTO DA TRASPORTO VMC È INDISPENSABILE PER CARICARE CON FACILITÀ LA MOTO SUL FURGONE. TUTTO IL TELAIO È INTERAMENTE REALIZZATO IN ACCIAIO SALDATO A MANO E LA COLORAZIONE È OTTENUTA CON VERNICIATURA EPOSSIDICA GOFFRATA PER DURARE NEL TEMPO. IL FISSAGGIO È POSSIBILE ATTRAVERSO I 4 FORI PRESENTI NELLA BASE DEL CAVALLETTO. GRAZIE AD UN SISTEMA BASCULANTE È SEMPLICE FERMARE O RILASCIARE LA RUOTA ANTERIORE DAL SUPPORTO. QUANDO NON È NECESSARIO LO SPOSTAMENTO DELLA MOTO IL CAVALLETTO È UTILIZZABILE ANCHE A CASA UNA VOLTA FISSATO AL PAVIMENTO O ALLA PARETE.

MOBILE BASEMENT STAND

CAVALLETTO BASE MOBILE



MOBILE BASEMENT STAND KG. 240 MAX
BASE CAVALLETTO MOBILE KG. 240

CAV04

VMC MOBILE BASEMENT STAND IS PERFECT TO MOVE A BIKE WITH CENTRAL STAND IN THE BOX OR IN A SHOP. IT IS REINFORCED AND MADE IN STRONG STEEL AND CAN CARRY HEAVY BIKES TILL 240 KG. IS EQUIPPED WITH FOUR HIGH RESISTANCE DOUBLE WHEEL.

LA BASE MOBILE PER CAVALLETTO CENTRALE VMC È IDEALE PER LO SPOSTAMENTO DELLA MOTO IN BOX O ALL'INTERNO DI UN NEGOZIO. È IN ACCIAIO RESISTENTE RINFORZATO PER CONSENTIRE LO SPOSTAMENTO DI MOTO FINO A 240 KG. DI PESO. È EQUIPAGGIATO CON 4 RUOTE DOPPIE PER CARICO ELEVATO.

POSITIONING TROLLEY

CARRELLO RIMESSAGGIO

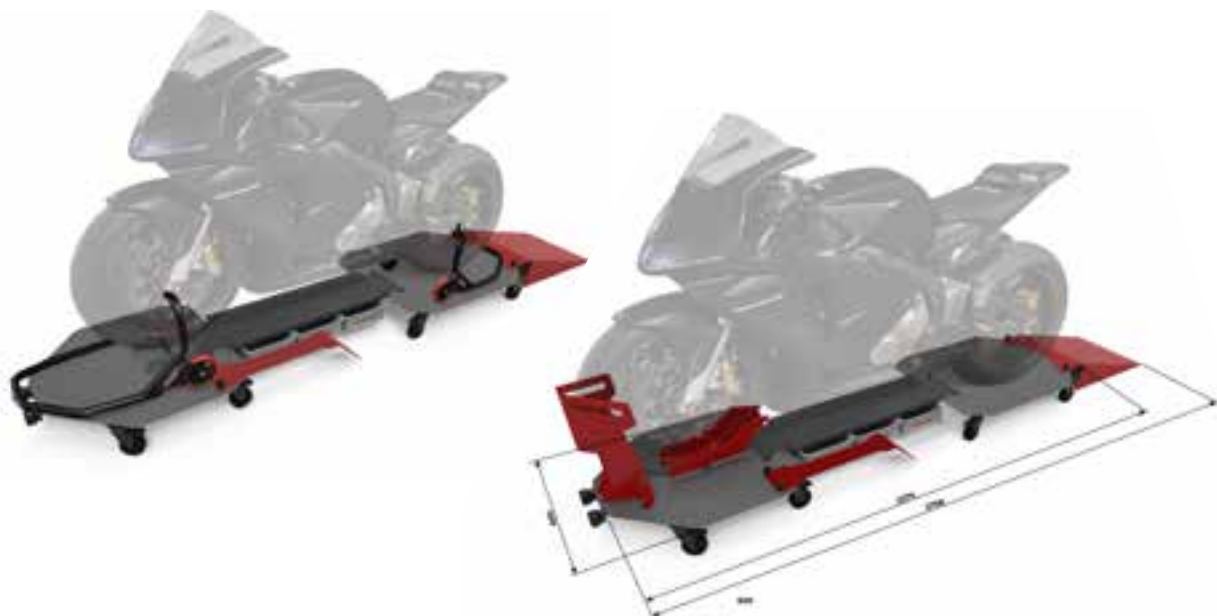

POSITIONING TROLLEY
CARRELLO RIMESSAGGIO

AR20

THE POSITIONING TROLLEY IS COMPOSED BY PIVOTING WHEELS WITH A BRAKE, ALLOWS 360° ROTATION WITH MOTORCYCLE ABOVE. THANKS TO THE LARGE PLATFORMS, IT IS POSSIBLE TO USE THE STANDS OF THE BIKE TO KEEP THE WHEELS RAISED OR TO PERFORM MAINTENANCE AND IT IS EQUIPPED WITH TRAY GLOVE BOX AND THANKS TO TWO NYLON PROTECTORS IS POSSIBLE TO AVOID MARKS ON THE WALL. THE PRODUCT IS EASY TO ASSEMBLE/DISASSEMBLE. IT IS PROVIDED WITH A CHOCK TO LOCK THE FRONT WHEEL WITH THE POSSIBILITY OF ADJUSTMENT ACCORDING THE DIMENSION OF THE WHEEL RIM. THE TRAPEZOIDAL STRUCTURE ALLOWS TO PLACE THE MOTORCYCLE IN THE CORNER AREAS OF THE GARAGE.

IL CARRELLO RIMESSAGGIO È DOTATO DI RUOTE PIVOTTANTI CON FRENO, CHE PERMETTONO LA ROTAZIONE A 360° DEL CARRELLO CON SOPRA LA MOTO. LE AMPIE PEDANE PERMETTONO DI POSIZIONARE I CAVALLETTI MOTO PER TENERE LE RUOTE SOLLEVATE O PER ESEGUIRE MANUTENZIONE ED È MUNITO DI VASCHETTE PORTAOGGETTI. IL PRODOTTO È DI FACILE ASSEMBLAGGIO/DISASSEMBLAGGIO. PROVVISTO DI UN CUNEIO PER BLOCCARE LA RUOTA ANTERIORE CON POSSIBILITÀ DI REGOLAZIONE IN BASE ALLE DIMENSIONI DEL CERCHIO. LA STRUTTURA TRAPEZOIDALE PERMETTE DI POSIZIONARE LA MOTO ANCHE IN ZONE ANGOLARI DEL BOX E GRAZIE AI DUE TAMPONI IN NYLON È POSSIBILE EVITARE DI LASCIARE SEGNI SUL MURO.

ATTENTION, ALARM WITH GPS



Kit GPS + sticker for positioning trolley
Kit GPS + adesivo per carrello rimessaggio

AR20G

DISPOSITIVO DI TRACCIAMENTO GPS (L'ATTIVAZIONE È A CARICO DEL CLIENTE) E UN ADESIVO "ATTENTION, ALARM WITH GPS" DA APPLICARE A SCELTA DEL CLIENTE.

GPS TRACKING DEVICE (ACTIVATION IS CHARGED TO CUSTOMER) AND A STICKER "ATTENTION, ALARM WITH GPS".



CHAIN LOCK FOR POSITIONING TROLLEY
BLOCCO CATENA PER CARRELLO RIMESSAGGIO

AR20C

A CLASP IS PROVIDED FOR WALL MOUNTING, USEFUL FOR THE PASSAGE OF THE CHAIN (THE CHAIN IS NOT INCLUDED).

VIENE FORNITO UN GANCIO PER IL FISSAGGIO A MURO, UTILE PER IL PASSAGGIO DELLA CATENA (LA CATENA NON È INCLUSA).



EXTENSION CABLE & LIGHT FOR POSITIONING TROLLEY
PROLUNGA & LUCE PER CARRELLO RIMESSAGGIO

AR20L

MAGNETIC LAMP WITH USB CHARGING ABLE TO HAVE LIGHT DURING MAINTENANCE WORK, EXTENSION CABLE WITH USB CONNECTIONS (MT 5),

LAMPADA MAGNETICA CON RICARICA USB PER POTER AVERE SEMPRE LA LUCE DURANTE I LAVORI DI MANUTENZIONE, MULTIPRESA RIAVVOLGENTE LUNGA CINQUE METRI CON QUATTRO PRESE ELETTRICHE E DUE PRESE USB.

STAND SUPPORT



STAND SUPPORT 'EASY'

SUPPORTI CAVALLETTO 'EASY'



STAND SUPPORT 'EASY'
SUPPORTI CAVALLETTO 'EASY'

SS04

55

THE NEW STAND SUPPORT ARE CREATED BY WORKING THE FULL ALUMINIUM BAR CNC, OBTAINING PERFECT COMPONENTS WITHOUT ANY DEFECTS. THE ANODIC OXIDATION TREATMENT COMPLETES THE SURFACE FINISHING WORK ENSURING BRIGHT AND BRIGHT COLORS OVER TIME. THEY ARE NECESSARY TO USE THE REAR FORK RACING STAND.

I NUOVI SUPPORTI CAVALLETTO NASCONO LAVORANDO LA BARRA PIENA DI ALLUMINIO SU TORNO A CONTROLLO NUMERICO OTTENENDO DEI COMPONENTI PERFETTI E PRIVI DI OGNI DIFETTO. IL TRATTAMENTO DI OSSIDAZIONE ANODICA COMPLETA IL LAVORO DI FINITURA SUPERFICIALE GARANTENDO COLORI BRILLANTI E VIVACI NEL TEMPO. INDISPENSABILI PER UTILIZZARE IL CAVALLETTO POSTERIORE A FORCHETTA PER IL SOLLEVAMENTO DELLA MOTO.



00	02	03	04	05	07	16
BLACK - NERO	BLUE - BLU	GOLD - ORO	RED - ROSSO	TITANIUM	GREEN - VERDE	ORANGE - ARANCIONE



MOTO COMPONENTS



VALTER

STAND SUPPORT 'SPECIAL'

SUPPORTI CAVALLETTO 'SPECIAL'



SPECIAL' HANDLEBAR ENDS
TERMINALI MANUBRIO 'SPECIAL'

SS02

57

ENTIRELY MADE WITH CNC MACHINERY IN ALUMINUM ALLOY ARE NECESSARY TO USE THE REAR FORK RACING STAND. THE SPECIAL MODEL HAS A LARGE FLANGE TO PROTECT SWING ARM FROM ACCIDENTAL CONTACT WITH STAND FORKS.

I SUPPORTI CAVALLETTO VMC SPECIAL SONO OTTENUTI LAVORANDO L'ALLUMINIO IN BARRA SU TORNI A CONTROLLO NUMERICO. QUESTI COMPONENTI SONO INDISPENSABILI PER UTILIZZARE IL CAVALLETTO POSTERIORE A FORCHETTA PER IL SOLLEVAMENTO DELLA MOTO. LA LARGA FLANGIA DEL MODELLO SPECIAL PROTEGGE IL FORCELLONE DA ACCIDENTALI CONTATTI CON LE FORCHETTE DEL CAVALLETTO CHE POTREBBERO CAUSARE GRAFFI O DANNI.



00	02	03	04	05	07	16
BLACK - NERO	BLUE - BLU	GOLD - ORO	RED - ROSSO	TITANIUM	GREEN - VERDE	ORANGE - ARANCIONE



STAND SUPPORT 'TRACK'

SUPPORTI CAVALLETTO 'TRACK'



TRACK' STAND SUPPORT
SUPPORTI CAVALLETTO 'TRACK'

SS03

TRACK STANDS SUPPORTS ARE MADE WITH CNC MACHINERY IN ALUMINUM ALLOY WITH A SPECIAL POLYMER SHELL. THEY HAVE A DOUBLE FUNCTION: REAR FORK RACING STAND SUPPORTS AND SWING ARM CRASH PROTECTIONS. THIS TRACK MODEL HAS ALSO A LARGE FLANGE TO SAVE SWING ARM FROM ACCIDENTAL CONTACT WITH STAND FORKS.

I SUPPORTI CAVALLETTO VMC TRACK SONO COMPOSTI DA DUE MATERIALI DIVERSI PER UN UTILIZZO PREVALENTEMENTE PISTA. QUESTI COMPONENTI SONO INDISPENSABILI PER UTILIZZARE IL CAVALLETTO POSTERIORE A FORCHETTA PER IL SOLLEVAMENTO DELLA MOTO. LA PARTE INTERNA È OTTENUTA LAVORANDO L'ALLUMINIO IN BARRA SU TORNI A CONTROLLO NUMERICO ED È LA STRUTTURA SOLIDA PER IL SOLLEVAMENTO DELLA MOTO. LA PARTE ESTERNA È REALIZZATA UTILIZZANDO UN POLIMERO SPECIALE CHE OFFRE UN'OTTIMA PROTEZIONE PER IL FORCELLONE IN CASO DI CONTATTO CON IL SUOLO. LA LARGA FLANGIA DEL MODELLO TRACK PROTEGGE IL FORCELLONE DA ACCIDENTALI CONTATTI CON LE FORCHETTE DEL CAVALLETTO CHE POTREBBERO CAUSARE GRAFFI O DANNI.

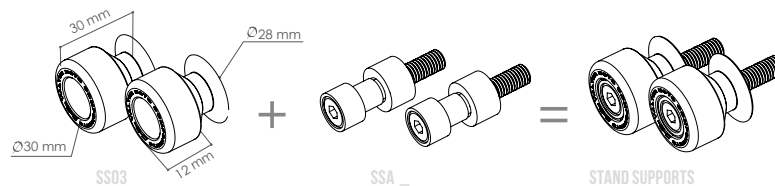

00	02	03	04	05	07	16
BLACK - NERO	BLUE - BLU	GOLD - ORO	RED - ROSSO	TITANIUM	GREEN - VERDE	ORANGE - ARANCIONE

STAND SUPPORT TITANIUM 'PRO'

SUPPORTI CAVALLETTO IN TITANIO 'PRO'



60

PRO' TITANIUM STAND SUPPORT
SUPPORTI CAVALLETTO TITANIO 'PRO'

SST01

STAND SUPPORTS ENTIRELY MADE FROM SOLID TITANIUM. THE OUTER DIAMETER IS 30 MM AND THE THICKNESS IS 24 MM.

SUPPORTI CAVALLETTO RICAVATI DAL PIENO IN TITANIO. IL DIAMETRO ESTERNO È 30 MM LO SPESSORE È 24 MM.

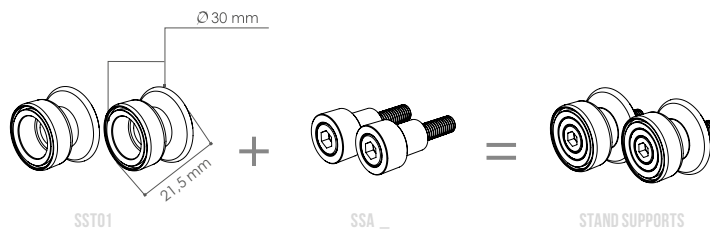

05
TITANIUM

Model - Modello	Year - Anno	Code - Codice
APRILIA		
RS250	95-02	SSA01
RSV 1000	98-08	SSA01
RSV4/R/APRC	09-22	SSA01
TUONO 1000	03-10	SSA01
TUONO V4	11-22	SSA01
BMW		
S 1000 RR	09-22	SSA19
	19-22	STA43
DUCATI		
749 / 999	03-06	SSA02
HONDA		
CBR 600 F	95-13	SSA02
CBR 600 RR	03-06	SSA02
	07-22	SSA16
CBR 900	94-03	SSA02
CBR 1000 R / RR	04-19	SSA02
	20-22	SSA19
VTR 1000 SP1 / 2	00-06	SSA02
HORNET 600	98-13	SSA02
HORNET 900	02-06	SSA02
KAWASAKI		
NINJA 250 R	07-13	SSA04
NINJA 300 R	12-17	SSA04
NINJA 400	18-22	SSA09
ZX 6-636 R / RR / ABS	98-06	SSA04
	07-08	SSA14
	09-12	SSA08
	13-22	SSA02
ZX 9 R	98-05	SSA04

Model - Modello	Year - Anno	Code - Codice
ZX 10 R	04-10	SSA04
	11-22	SSA02
Z 1000 SX	07-12	SSA04
	13-18	SSA02
ZZR 1400 R	06-18	SSA04
ER6N	05-16	SSA04
Z 650	17-22	SSA16
Z 750	03-13	SSA04
Z 800	13-16	SSA20
Z 900	17-22	SSA09
Z 1000	03-06	SSA08
	07-13	SSA04
	14-18	SSA02
VERSYS 650	06-22	SSA04
SUZUKI		
GSX 600 / 750 R	01-05	SSA02
	06-10	SSA09
	11-17	SSA02
GSX 1000 R	05-06	SSA09
	07-22	SSA02
GSX 1300R HAYABUSA	08-17	SSA09
V STROM 1000	16-19	SSA02
GSX -S125	17-20	SSA20
GSR 600	06-12	SSA02
GLADIUS 650	09-15	SSA02
SV650	16-22	SSA02
GSR 750	10-16	SSA02
GSX -S750	17-20	SSA20
GSX -S1000 -950	15-22	SSA02
B-KING	07-12	SSA09

Model - Modello	Year - Anno	Code - Codice
YAMAHA		
R125	08-18	SSA01
R3	15-22	SSA01
R6	99-16	SSA01
	17-22	SSA22
R1	98-14	SSA01
	15-22	SSA21
TDM 900	02-14	SSA01
FAZER 1000	00-05	SSA01
XJ6	09-15	SSA01
FZ6	04-11	SSA01
FZ8	10-16	SSA01
FZ1	06-15	SSA01
MT09	13-16	SSA01
MT10	16-22	SSA21
TRIUMPH		
DAYTONA 675 / R	06-16	SSA02
STREET TRIPLE / R	07-16	SSA02

	Code - Codice
bolts Ø 6mm	SSA01
bolts Ø 8mm	SSA02
bolts Ø 10mm	SSA04

LEVER PROTECTION



LEVER PROTECTION

PROTEZIONE LEVA



"Evo" LEVER PROTECTION
PROTEZIONE LEVA FRENO "Evo"

SRO2U

VMC LEVER PROTECTION IS ENTIRELY MADE WITH CNC MACHINERY IN ERGAL 7075 T5 ALLOY. THE REGULATION SYSTEM IS DEVELOPED TO ALLOW ALL SETTING: HEIGHT, LOWNESS, WIDENING AND LENGHT. THANKS TO A DEDICATED FIXING KIT SOLD SEPARATELY IT FITS PERFECTLY ON THE BIKE AND CAN BE MOUNTED ON BOTH LEFT OR RIGHT SIDE.

LA PROTEZIONE LEVA VMC SAFEROD EVO È REALIZZATA IN ALLUMINIO LAVORATO CON CENTRI DI LAVORO CNC. IL SISTEMA DI REGOLAZIONE INTERNO È STATO STUDIATO PER PERMETTERE TUTTE LE MODIFICHE DI POSIZIONAMENTO DELLA PROTEZIONE LEVA: ALTEZZA, LARGHEZZA E LUNGHEZZA. GRAZIE AI DIVERSI ATTACCHI VENDUTI SEPARATAMENTE È POSSIBILE MONTARE LA PROTEZIONE LEVA SUI PIÙ COMUNI MODELLI DI MOTO IN CIRCOLAZIONE. LO STUDIO SU QUESTO PRODOTTO HA PERMESSO DI OTTENERE UN PARALEVA SIMMETRICO CHE PUÒ ESSERE INSTALLATO SIA SULLA DESTRA CHE SULLA SINISTRA DEL MANUBRIO.



00	02	03	04	05	07	16
BLACK - NERO	BLUE - BLU	GOLD - ORO	RED - ROSSO	TITANIUM	GREEN - VERDE	ORANGE - ARANCIONE



SPARE PARTS

	Code - Codice
Handlebar Ø 10	STA28
Handlebar Ø 12	STA29
Handlebar Ø 13	STA11
Handlebar Ø 14	STA30
Handlebar Ø 16	STA10
Handlebar Ø 18	STA31
Handlebar Ø 20	STA32
Handlebar Ø 22	STA33

STA11: FOR OUR HANDLEBARS - ADATTABILE AI NOSTRI MANUBRI
TMA10: FOR OUR RACE CLIP-ON - ADATTABILE AI NOSTRI SEMIMANUBRI

Model - Modello	Year - Anno	Code - Codice
APRILIA		
RSV 1000	98-08	STA10
RSV4/R/APRC	09-22	STA10
TUONO 1000	03-10	STA10
TUOVO V4	11-22	STA10
BMW		
S 1000 R / RR	09-18	STA25
	19-22	STA43
F 800 R	09-14	STA26
DUCATI		
748 / 916 / 996 / 998	93-03	STA10
749 / 999	03-06	STA10
848	08-13	STA28
1098 / 1198	07-11	STA10
PANIGALE 899	14-15	STA10
PANIGALE 1199 / 1299	12-14	STA10
PANIGALE V2	21-22	STA10
PANIGALE V4	18-22	STA10
MONSTER 696 / 796	08-15	STA10
MONSTER S4R / S2R	01-08	STA04
STREET FIGHTER 848 / 1100	09-15	STA11
MONSTER 821	14-17	STA10
MONSTER 1100	09-13	STA11
DIAVEL	11-19	STA11
SCRAMBLER	15-17	STA10
HONDA		
CBR 600 F	95-13	STA01
CBR 650 R	19-22	STA41
CBR 600 RR / ABS	03-16	STA01
CBR 1000 RR / ABS	04-21	STA01
VTR 1000 SP1 / 2	00-06	STA01
X -ADV	17-22	STA41
AFRICA TWIN	17-19	STA41
HORNET 600	98-13	STA01
CB 650 R	19-22	STA41
HORNET 900	02-06	STA01

Model - Modello	Year - Anno	Code - Codice
CB 1000 R	08-22	STA01
KAWASAKI		
NINJA 250 R	07-13	STA04
NINJA 300	12-17	STA04
NINJA 400	18-22	STA04
ZX 6-636 R / RR	98-06	STA04
	07-08	STA18
	09-22	STA23
ZX 10 R/ABS	04-15	STA18
	16-22	STA23
Z 1000 SX	10-18	STA04
ZZR 1400 R	06-18	STA04
ER6N	05-08	STA04
	09-16	STA23
Z 650	17-22	STA34
Z 750 / R / ABS	03-13	STA04
Z 800 / R / ABS	13-16	STA04
Z 900	17-22	STA04
Z 1000 / ABS	03-18	STA04
KTM		
SUPERDUKE 1290	14-16	STA11
MV AGUSTA		
F3	11-22	STA35
F4	10-18	STA35
TURISMO VELOCE	14-22	STA17
DRAGSTER (EURO3)	14-17	STA35
DRAGSTER (EURO4 / EURO 5)	16-22	STA39
B3	13-22	STA17
BRUTALE 1000	19-22	STA40
SUZUKI		
GSX 600 R	01-05	not required
	06-17	STA15
GSX 750 R	00-05	not required
	06-17	STA15
GSX 1000 R	03-04	not required
	05-16	STA15

Model - Modello	Year - Anno	Code - Codice
	17-22	STA36
GSX 1300 R HAYABUSA	08-17	not required
V STROM 1000	16-19	STA31
GSX -S125	17-22	STA31
SV650	99-02	STA09
	03-12	not required
	16-22	STA10
GLADIUS 650	09-15	STA24
GSR 750	10-16	not required
GSX -S750	17-20	not required
GSX -S1000 -950	15-22	STA10
B-KING	07-12	STA24
YAMAHA		
R125	08-18	STA13
R3	15-17	STA08
R6	99-05	STA06
	06-22	STA08
R1	98-01	not required
	02-22	STA08
TDM 900	02-14	STA13
XJ6	09-15	STA13
FZ6	08-11	STA13
FZ8	10-16	STA08
FZ1	06-15	STA08
MT07 / TRACER	14-22	STA13
MT09 / TRACER	13-22	STA13
MT10	16-22	STA13
T-MAX	02-18	STA13
TRIUMPH		
DAYTONA 675 / R	06-12	STA19
	13-16	STA08
STREET TRIPLE / R	07-12	STA21
	13-16	STA08
SPEED TRIPLE / R	05-10	STA16
	11-15	STA27



TITANIUM

LEVER PROTECTION SHIELD IN TITANIUM

PARAMANI IN TITANIO



LEFT TITANIUM LEVER PROTECTION COVER
COVER PROTEZIONE LEVA IN TITANIO SINISTRA

RIGHT TITANIUM LEVER PROTECTION COVER
COVER PROTEZIONE LEVA IN TITANIO DESTRA

ALS05TSL

ALS05TSR

TITANIUM COVERS ARE MADE TO GIVE A SPECIAL LOOK TO THE BIKE. MADE IN HIGH THICKNESS TITANIUM LASER CUTTED TO MAKE THEM AS LIGHTER AS POSSIBLE. THEY ARE FOLDED FOLLOWING THE VMC DESIGN TO OFFER A UNIQUE PRODUCT.

LE COVER IN TITANIO SONO STATE SVILUPPATE PER DARE UN NUOVO LOOK ALLA MOTO. VENGONO REALIZZATE DA UN SOTTILE FOGLIO IN TITANIO TAGLIATO LASER PER RENDERLE PIÙ LEGGERE POSSIBILE. VENGONO PIEGATE SEGUENDO IL DESIGN VMC PER OFFRIRE UN PRODOTTO UNICO NEL SUO GENERE. IL KIT COMPRENDE SOLAMENTE LA COVER ED IL SUPPORTO.

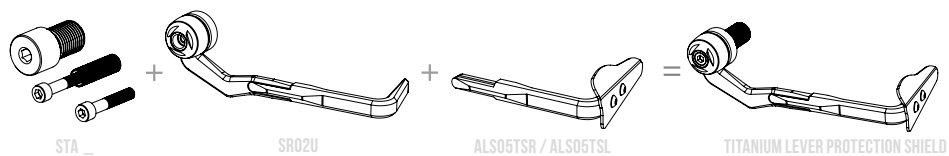

05
TITANIUM

ALUMINUM LEVER PROTECTION SHIELD

PARAMANI IN ALLUMINIO



LEFT LEVER PROTECTION COVER
COVER PROTEZIONE LEVA SINISTRA

ALS05L

RIGHT LEVER PROTECTION COVER
COVER PROTEZIONE LEVA DESTRA

ALS05R

ALUMINUM COVERS ARE MADE TO GIVE A SPECIAL LOOK TO THE BIKE. MADE IN HIGH THICKNESS ALUMINUM LASER CUTTED TO MAKE THEM AS LIGHTER AS POSSIBLE. THEY ARE FOLDED FOLLOWING VMC DESIGN TO PERFECTLY FIT ON THE SPECIFIC BIKE TO WHICH THEY ARE DEVELOPED FOR. THE KIT INCLUDES ONLY THE COVER AND THE SUPPORT. A VMC LEVER PROTECTION KIT SAFEROD (SOLD SEPARATELY) MUST BE PREVIOUSLY INSTALLED TO FIX THIS COVER.

LE COVER IN ALLUMINIO SONO STATE SVILUPPATE PER DARE UN NUOVO LOOK ALLA MOTO. REALIZZATE DA UN SOTTILE FOGLIO IN ALLUMINIO TAGLIATO LASER PER RENDERLE PIÙ LEGGERE POSSIBILE. VENGONO PIEGATE SEGUENDO IL DESIGN VMC PER ADATTARSI AL MODELLO DI MOTO PER CUI SONO STATE SVILUPPATE. IL KIT COMPRENDE SOLAMENTE LA COVER ED IL SUPPORTO. E' NECESSARIO AVER MONTATO UN KIT PROTEZIONE LEVA VMC SAFEROD (VENDUTO SEPARATAMENTE) PER IL FISSAGGIO DELLA COVER. DISPONIBILI NEL SOLO COLORE NERO.

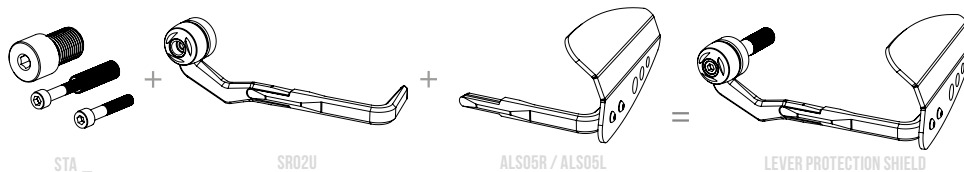

STA _

SR02U

ALS05R / ALS05L

LEVER PROTECTION SHIELD

00
BLACK - NERO



RIGHT ALUMINUM 'S' LEVER PROTECTION COVER
COVER 'S' PROTEZIONE LEVA DESTRA

ALSO5AR 00

LEFT ALUMINUM 'S' LEVER PROTECTION COVER
COVER 'S' PROTEZIONE LEVA SINISTRA

ALSO5AL 00

ALUMINUM COVERS ARE MADE TO GIVE A SPECIAL LOOK TO THE BIKE. MADE IN HIGH THICKNESS ALUMINUM LASER CUTTED TO MAKE THEM AS LIGHTER AS POSSIBLE. THEY ARE FOLDED FOLLOWING VMC DESIGN TO PERFECTLY FIT ON THE SPECIFIC BIKE TO WHICH THEY ARE DEVELOPED FOR. THE KIT INCLUDES ONLY THE COVER AND THE SUPPORT. A VMC LEVER PROTECTION KIT SAFEROD (SOLD SEPARATELY) MUST BE PREVIOUSLY INSTALLED TO FIX THIS COVER.

LE COVER IN ALLUMINIO SONO STATE SVILUPPATE PER DARE UN NUOVO LOOK ALLA MOTO. REALIZZATE DA UN SOTTILE FOGLIO IN ALLUMINIO TAGLIATO LASER PER RENDERLE PIÙ LEGGERE POSSIBILE. VENGONO PIEGATE SEGUENDO IL DESIGN VMC PER ADATTARSI AL MODELLO DI MOTO PER CUI SONO STATE SVILUPPATE. IL KIT COMPRENDE SOLAMENTE LA COVER ED IL SUPPORTO. E' NECESSARIO AVER MONTATO UN KIT PROTEZIONE LEVA VMC SAFEROD (VENDUTO SEPARATAMENTE) PER IL FISSAGGIO DELLA COVER. DISPONIBILI NEL SOLO COLORE NERO.



00
BLACK - NERO

HANDLEBAR ENDS



HANDLEBAR ENDS 'EASY'

TERMINALI MANUBRIO 'EASY'



EASY' HANDLEBAR ENDS
TERMINALI MANUBRIO 'EASY'

TM04

THE NEW HANDLEBAR ENDS ARE CREATED BY WORKING THE FULL ALUMINIUM BAR CNC, OBTAINING PERFECT COMPONENTS WITHOUT ANY DEFECTS. THE ANODIC OXIDATION TREATMENT COMPLETES THE SURFACE FINISHING WORK ENSURING BRIGHT AND BRIGHT COLORS OVER TIME.

I NUOVI TERMINALI MANUBRIO NASCONO LAVORANDO LA BARRA PIENA DI ALLUMINIO SU TORNIO A CONTROLLO NUMERICO OTTENENDO DEI COMPONENTI PERFETTI E PRIVI DI OGNI DIFETTO. IL TRATTAMENTO DI OSSIDAZIONE ANODICA COMPLETA IL LAVORO DI FINITURA SUPERFICIALE GARANTENDO COLORI BRILLANTI E VIVACI NEL TEMPO.



00	02	03	04	05	07	16
BLACK - NERO	BLUE - BLU	GOLD - ORO	RED - ROSSO	TITANIUM	GREEN - VERDE	ORANGE - ARANCIONE



VALTER
Just racing parts

HANDLEBAR ENDS 'TOURING'

TERMINALI MANUBRIO 'TOURING'



TOURING' HANDLEBAR ENDS
TERMINALI MANUBRIO 'TOURING'

TM02

77

ALUMINUM HANDLEBAR ENDS TOURING WITH ANTI-VIBRATIONS AVP CORE. THE INNER PIVOT OF 65GR REDUCES THE VIBRATION. IT IS RECOMMENDED FOR TOURING USE.

INTERAMENTE LAVORATI CON TORNI A CONTROLLO NUMERICO, I TERMINALI MANUBRIO VMC TOURING HANNO UN INVOLUCRO ESTERNO IN ALLUMINIO ANODIZZATO ED UN CUORE INTERNO IN PESANTE ACCIAIO AVP. IL PERNO INTERNO DEL PESO DI 65 GR. PERMETTE DI RIDURRE AL MINIMO LE VIBRAZIONI DEL MANUBRIO PER UN UTILIZZO PREVALENTEMENTE TURISTICO DELLA MOTO.

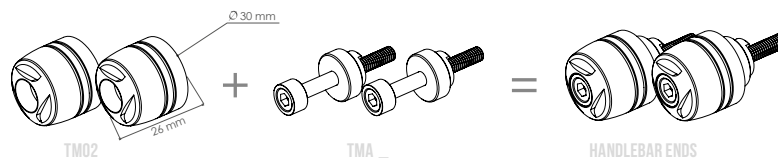

00	02	03	04	05	07	16
BLACK - NERO	BLUE - BLU	GOLD - ORO	RED - ROSSO	TITANIUM	GREEN - VERDE	ORANGE - ARANCIONE



HANDLEBAR ENDS 'TRACK'

TERMINALI MANUBRIO 'TRACK'



TRACK' HANDLEBAR ENDS
TERMINALI MANUBRIO 'TRACK'

TM03

TWO DIFFERENT MATERIALS IS THE TRIKING NOTE OF THIS PRODUCT DEVELOPED MAINLY FOR RACING USE. OUTSIDE COVER: SPECIAL POLYMER TO REDUCE IMPACT AND SLIDING. INSIDE CORE: MADE WITH CNC MACHINERY IN ALUMINUM ALLOY WICH GIVES THESE SLIDERS A STRONG PROTECTION. INTERNAL PIVOT OF 40GR TO REDUCE THE VIBRATION.

INTERAMENTE LAVORATI CON TORNI A CONTROLLO NUMERICO, I TERMINALI MANUBRIO VMC TRACK HANNO UN INVOLUCRO ESTERNO IN ALLUMINIO ANODIZZATO, UN CUORE INTERNO IN PESANTE ACCIAIO AVP ED UNA PROTEZIONE IN NYLON. IL PERNO INTERNO DEL PESO DI 40 GR. PERMETTE DI RIDURRE AL MINIMO LE VIBRAZIONI DEL MANUBRIO MENTRE LO SLIDER IN NYLON RIDUCE LA VELOCITÀ DI SCIVOLATA E CONTRIBUISCE AD ASSORBIRE L'IMPATTO IN CASO DI CADUTA.

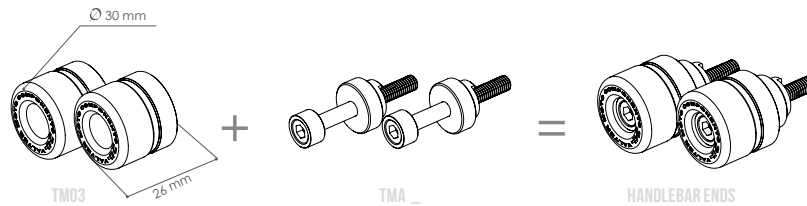

00	02	03	04	05	07	16
BLACK - NERO	BLUE - BLU	GOLD - ORO	RED - ROSSO	TITANIUM	GREEN - VERDE	ORANGE - ARANCIONE

HANDLEBAR ENDS TITANIUM 'PRO'

TERMINALI MANUBRIO IN TITANIO 'PRO'



PRO' TITANIUM HANDLEBAR ENDS
TERMINALI MANUBRIO TITANIO 'PRO'

TMT01

HANDLEBAR ENDS ENTIRELY MADE FROM SOLID TITANIUM. THE OUTER DIAMETER IS 30 MM AND THE THICKNESS IS 21 MM.

TERMINALI MANUBRIO INTERAMENTE RICAVATI DAL PIENO IN TITANIO. IL DIAMETRO ESTERNO È 30 MM MENTRE LO SPESSORE È 21 MM.

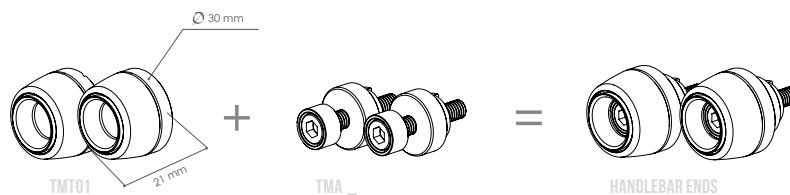

05
TITANIUM

Model - Modello	Year - Anno	Code - Codice
APRILIA		
RSV 1000	98-08	TMA10
RSV4/R/APRC	09-22	TMA10
TUONO 1000	03-10	TMA10
TUONO V4	11-22	TMA10
BMW		
S 1000 R / RR	09-18	TMA25
	19-22	TMA43
F 800 R	09-14	TMA26
DUCATI		
748 / 916 / 996 / 998	93-03	TMA10
749 / 999	03-06	TMA10
848	08-13	TMA28
1098 / 1198	07-11	TMA10
PANIGALE 899	14-15	TMA10
PANIGALE 1199 / 899 / 1299	12-15	TMA10
PANIGALE V2	21-22	TMA10
PANIGALE V4	18-22	TMA10
MONSTER 696 / 796	08-15	TMA10
MONSTER S4R / S2R	01-08	TMA04
STREET FIGHTER 848 / 1100	09-15	TMA11
MONSTER 821	14-17	TMA10
MONSTER 1100	09-13	TMA11
DIAVEL	11-19	TMA11
SCRAMBLER	15-18	TMA10
HONDA		
CBR 600 F	95-13	TMA01
CBR 600 RR / ABS	03-16	TMA01
CBR 650 R	19-22	TMA41
CBR 1000 RR / ABS	04-22	TMA01
VTR 1000 SP1 / 2	00-06	TMA01
X -ADV	17-22	TMA42
AFRICA TWIN	17-19	TMA42
HORNET 600	98-13	TMA01
CB 650 R	19-22	TMA41
HORNET 900	02-06	TMA01
CB 1000 R	08-17	TMA01
KAWASAKI		
NINJA 250 R	07-13	TMA04

Model - Modello	Year - Anno	Code - Codice
NINJA 300 R	12-17	TMA04
NINJA 400	18-22	TMA04
ZX 6-636 R/RR	98-06	TMA04
	07-08	TMA18
	09-22	TMA23
ZX 9 R	98-05	TMA04
ZX 10 R	04-15	TMA18
	16-22	TMA23
Z 1000 SX	07-18	TMA04
ZZR 1400 R	06-18	TMA04
ER6N	05-08	TMA04
	09-16	TMA23
Z 650	17-22	TMA34
Z 750 / R	03-13	TMA04
Z 800 / R	13-16	TMA04
Z 900	17-22	TMA04
Z 1000	03-18	TMA04
KTM		
SUPERDUKE 1290	14-18	TMA11
MV AGUSTA		
F3	11-22	TMA35
F4	10-18	TMA35
TURISMO VELOCE	14-22	TMA37
DRAGSTER (EURO3)	14-15	TMA35
DRAGSTER (EURO4 / EURO 5)	16-22	TMA39
B3	13-22	TMA37
BRUTALE 1000 RR	19-22	TMA40
SUZUKI		
GSX 600 / 750 R	01-03	TMA09
	04-05	TMA02
	06-17	TMA15
GSX 1000 R	01-02	TMA09
	03-04	TMA02
	05-16	TMA15
	17-22	TMA36
GSX 1300 R HAYABUSA	08-17	TMA02

Model - Modello	Year - Anno	Code - Codice
V STROM 1000	16-19	TMA29
GSX -S125	17-22	TMA29
GSR 600	06-12	TMA09
GLADIUS 650	09-15	TMA24
SV 650	99-02	TMA09
	03-12	TMA02
	16-22	TMA10
GSR 750	10-16	TMA02
GSX -S750	17-20	TMA02
GSX -S1000 -950	15-22	TMA10
SV 1000	03-06	TMA02
B-KING	07-12	TMA24
YAMAHA		
R125	08-18	TMA13
R6	99-05	TMA06
	06-22	TMA08
R1	98-01	TMA02
	02-22	TMA08
TDM 900	02-14	TMA13
FAZER 1000	00-05	TMA13
XJ6	09-15	TMA13
FZ6	04-11	TMA13
FZ8	10-16	TMA08
FZ1	06-15	TMA13
MT07 / TRACER	14-22	TMA13
MT09 / TRACER	13-22	TMA13
MT10	16-22	TMA13
T-MAX	08-16	TMA13
TRIUMPH		
DAYTONA 675 / R	06-12	TMA19
	13-16	TMA08
STREET TRIPLE / R	07-12	TMA21
	13-17	TMA08
SPEED TRIPLE / R	05-07	TMA16
	08-10	TMA22
	11-15	TMA27

LICENSE PLATE HOLDER



'PISTA' LICENSE PLATE HOLDER

PIASTRA PORTATARGA 'PISTA'



'PISTA' LICENSE PLATE HOLDER STEEL
PIASTRA PORTATARGA ACCIAIO 'PISTA'

PRTPA

PISTA LICENSE PLATE HOLDER IS MADE WITH STRONG STEEL ALLOY. IT IS PROVIDED WITH ADJUSTABLE TURN LIGHTS SUPPORTS. THERE IS A BOLT TO BLOCK INCLINATION TO THE RIGHT POSITION. IT IS POSSIBLE TO CHANGE INCLINATION REMOVING BLOCK BOLT WHEN THIS IS ADMITTED. A VALTER MOTO COMPONENTS RESIN STICKER IS INCLUDED TO COVER LICENSE PLATE LIGHT HOLES IF NEEDED.

IL PORTATARGA VMC MODELLO PISTA È REALIZZATO IN SOLIDO ACCIAIO SPESSORE DUE MM. REALIZZATO NEL SOLO COLORE NERO VIENE FORNITO COMPRENSIVO DEI SUPPORTI FRECCHE UNIVERSALI E NE PERMETTE LA REGOLAZIONE IN ALTEZZA. UNA VITE LATERALE DI BLOCCO PERMETTE DI FERMARE LA REGOLAZIONE DEL PORTATARGA NELLA POSIZIONE CORRETTA PER LA NORMATIVA. NEL CASO FOSSE CONSENTITO, LA RIMOZIONE DELLA VITE PERMETTE DI REGOLARE L'INCLINAZIONE DELLA TARGA. NELLA CONFEZIONE È PRESENTE UN ADESIVO VMC RESINATO DA UTILIZZARE PER COPRIRE I FORNI DI FISSAGGIO DELLA LUCE TARGA NEL CASO NON VENISSERO UTILIZZATI. COME DA NORMATIVA, PER OGNI PORTATARGA VIENE FORNITO IL CATADIOTTRO RIFLETTENTE OMOLOGATO.



00
BLACK - NERO



www.kawasaki.com



MADE IN ITALY

'EXTREME' LICENSE PLATE HOLDER

PIASTRA PORTATARGA 'EXTREME'



'EXTREME' LICENSE PLATE HOLDER ALU
PIASTRA PORTATARGA ALLUMINIO 'EXTREME'

PRTPX

EXTREME LICENSE PLATE HOLDER IS MADE WITH ALUMINUM ALLOY. IT IS PROVIDED WITH ADJUSTABLE TURN LIGHTS SUPPORTS. THERE IS A BOLT TO BLOCK INCLINATION TO THE RIGHT POSITION. WITH A EXTREME LICENSE PLATE HOLDER IT IS POSSIBLE TO CHANGE ALSO HEIGHT POSITION. A VALTER MOTO COMPONENTS RESIN STICKER IS INCLUDED TO COVER LICENSE PLATE LIGHT HOLES IF NEEDED.

IL PORTATARGA VMC MODELLO EXTREME È LEGGERISSIMO IN QUANTO REALIZZATO IN ALLUMINIO SPESSORE 3 MM. DISPONIBILE NEL COLORE NERO CON SUPPORTO SILVER VIENE FORNITO COMPRESIVO DEI SUPPORTI FRECCHE UNIVERSALI E NE PERMETTE LA REGOLAZIONE IN ALTEZZA. UNA VITE LATERALE DI BLOCCO PERMETTE DI FERMARE LA REGOLAZIONE DEL PORTATARGA NELLA POSIZIONE CORRETTA PER LA NORMATIVA. NEL CASO FOSSE CONSENTITO, LA RIMOZIONE DELLA VITE PERMETTE DI REGOLARE L'INCLINAZIONE DELLA TARGA. GRAZIE AL SUPPORTO SILVER IL PORTATARGA EXTREME OFFRE LA POSSIBILITÀ DI UN ULTERIORE REGOLAZIONE DELLA TARGA SULL'ASSE VERTICALE PER CUI È POSSIBILE VARIARE LA DISTANZA DA TERRA. COME DA NORMATIVA, PER OGNI PORTATARGA VIENE FORNITO IL CATADIOTTRO RIFLETTENTE OMOLOGATO.

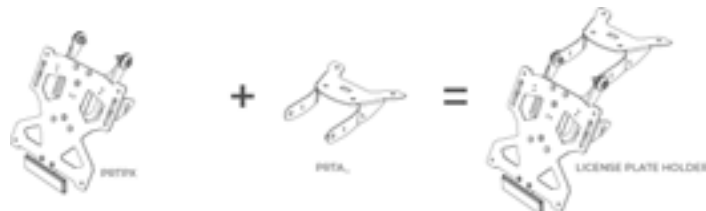

00
BLACK - NERO

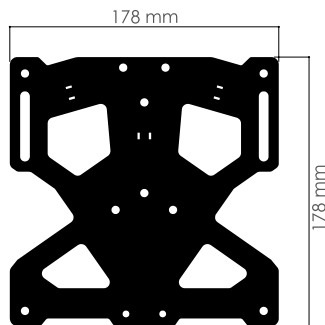

ITALY

Nation - Nazione	Code - Codice
Switzerland	P RTPX CH
Germany	P RTPX DE
Spain	P RTPX E
France	P RTPX F
Netherlands	P RTPX NL
Japan	P RTPX J

Nation - Nazione	Code - Codice
Switzerland	P RTPA CH
Germany	P RTPA DE
Spain	P RTPA E
France	P RTPA F
Sweden	P RTPA S

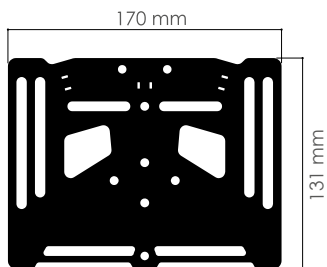

SWITZERLAND

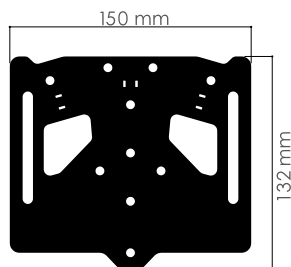

GERMANY

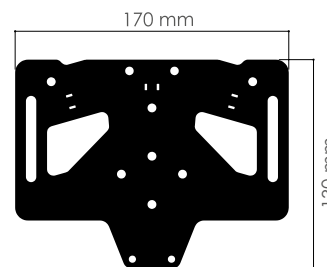

FRANCE

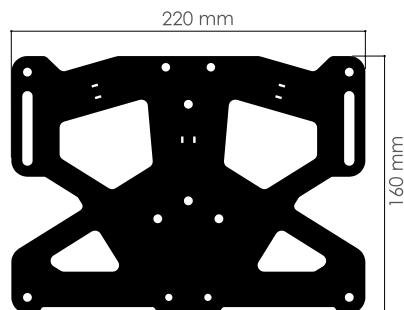

SPAIN

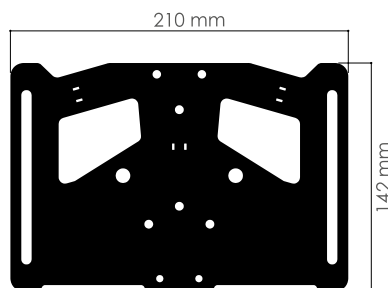

NETHERLANDS

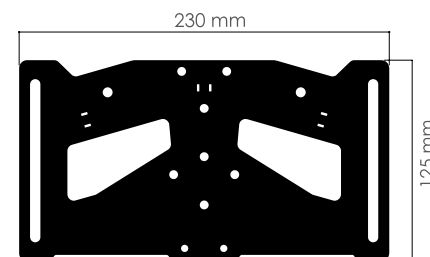

JAPAN

Model - Modello	Year - Anno	Code - Codice
APRILIA		
RSV4/R/APRC	09-20	PRTAA01
TUONO V4	11-20	PRTAA01
BMW		
S 1000 RR	09-11	PRTAB01
S 1000 RR/HP4	12-14	PRTAB04
S 1000 RR	15-18	PRTAB05
	19-22	PRTAB06
DUCATI		
749 / 999	03-06	PRTAD02
848 / 1098 / 1198	07-13	PRTAD03
PANIGALE 899 / 1199	12-15	PRTAD05
MONSTER 696 / 796 / 1100	08-14	PRTAD04**
HONDA		
CBR 600 F	11-13	PRTAH09
CBR 600 RR	03-04	PRTAH05
	05-06	PRTAH06
	07-12	PRTAH07**
	13-16	PRTAH11
	13-16	PRTAH11A*
CBR 650 R	19-22	PRTAH13
CBR 1000 RR	04-05	PRTAH05
	06-07	PRTAH06
CBR 1000 RR (NO ABS)	08-16	PRTAH08
CBR 1000 RR ABS	08-16	PRTAH10
	17-19	PRTAH12
AFRICA TWIN	17-19	PRTAH14
HORNET 600	07-13	PRTAH09
CB 650 R	19-22	PRTAH13
CB 1000 R	08-17	PRTAH09
KAWASAKI		
NINJA 400	18-21	PRTAK19
ZX 6-636 R / RR	03-04	PRTAK01
	05-06	PRTAK03
	07-08	PRTAK06**
	09-17	PRTAK08
ZX 10 R	06-07	PRTAK05
	08-10	PRTAK08

Model - Modello	Year - Anno	Code - Codice
	11-15	PRTAK12
	16-19	PRTAK16
Z 1000 SX	07-18	PRTAK11
ZZR1400R	06-18	PRTAK09
VERSYS 650	15-22	PRTAK11
ER6N	05-08	PRTAK04
	09-11	PRTAK10
	12-16	PRTAK15
Z 650	17-22	PRTAK18
Z 750 / R	03-06	PRTAK01
	07-13	PRTAK07
Z 800	13-16	PRTAK13
Z 900	17-22	PRTAK17
Z 1000	03-06	PRTAK01
	07-09	PRTAK07
	10-13	PRTAK11
	14-20	PRTAK14
KTM		
SUPERDUKE 1290	14-19	PRTA001
MV AGUSTA		
F3	11-22	PRTAM03
F4	13-18	PRTAM05
B3	11-15	PRTAM04
B4	06-18	PRTAM01
SUZUKI		
GSX 600 / 750R	04-05	PRTAS03
	06-07	PRTAS06
	08-10	PRTAS09
	11-17	PRTAS14
GSX 1000 R	05-06	PRTAS04
	07-08	PRTAS08
	09-16	PRTAS11
	17-22	PRTAS19
GSX 1300R HAYABUSA	08-17	PRTAS10
GSX -S125	17-22	PRTAS20
SV650	03-12	PRTAS05
	16-18	PRTAS17
GLADIUS 650	03-11	PRTAS05

Model - Modello	Year - Anno	Code - Codice
GLADIUS	09-15	PRTAS13**
GSR 750	10-16	PRTAS15
GSX -S750	17-20	PRTAS18
GSX -S1000 -950	15-22	PRTAS16
B-KING	07-12	PRTAS12
YAMAHA		
R125	08-18	PRTAY11
R3	15-18	PRTAY16
R6	03-05	PRTAY01
	06-16	PRTAY05
	17-19	PRTAY18
R1	02-03	PRTAY01
	04-06	PRTAY03
	07-08	PRTAY07
	09-14	PRTAY09
	09-14	PRTAY09A*
	15-20	PRTAY15
XJ6	09-15	PRTAY10
FZ6	04-11	PRTAY04
FZ8	10-16	PRTAY06
FZ1	06-15	PRTAY06
MT07	14-17	PRTAY14
MT09	13-16	PRTAY13
MT10	16-22	PRTAY17
T-MAX	08-11	PRTAY08
	12-16	PRTAY12
TRIUMPH		
DAYTONA 675 / R	06-12	PRTAT02
	13-16	PRTAT06
STREET TRIPLE / R	13-16	PRTAT06
SPEED TRIPLE / R	05-07	PRTAT01
	08-10	PRTAT04
	11-15	PRTAT05
	2022	PRTAT07
UNIVERSAL		
	ALL	PRTAU01

*AFTER MARKET SILNCER - *MARMITTA AFTER MARKET

**REAR LIGHT ENCLOSED - **LUCE POSTERIORE INCLUSA



KAWASAKI

MADE IN ITALY

KING' LICENSE PLATE

PORTATARGA 'KING'



KING LICENSE PLATE HOLDER IS DEVELOPED TO MOVE DOWN THE LICENSE PLATE OVER REAR WHEEL. BOTH ARM AND FIXING DEVICE ARE MADE WITH ERGAL 7075 AND ARE FIXED TO THE SWINGARM BY THE WHEEL AXLE. IT ALLOWS TO CHANGE PLATE INCLINATION AND HEIGHT TO FIND THE CORRECT POSITION. CABLE WIRES FOR LICENSE LIGHT AND TURN LIGHT INDICATORS IS INCLUDED. IT IS PROVIDED WITH ALL MOUNTING PARTS NEEDED AND WITH DEDICATED UNDERTAIL HOLE COVER.

IL PORTATARGA KING SVILUPPATO DA VMC PERMETTE DI SPOSTARE LA POSIZIONE DELLA TARGA DA SOTTO IL CODONE ALLA ZONA VICINA ALLA RUOTA POSTERIORE. IL TRALICCIO ED IL SISTEMA DI FISSAGGIO AL FORCELLONE SONO ENTRAMBI REALIZZATI IN ERGAL 7075 LAVORATI DAL PIENO CON MACCHINE CNC. IL SISTEMA DI MONTAGGIO OFFRE DIVERSE POSSIBILITÀ DI REGOLAZIONE DELLA PIASTRA PORTATARGA PER TROVARE IL POSIZIONAMENTO DESIDERATO. LA PIASTRA PORTATARGA È DELLA LINEA EXTREME IN ALLUMINIO SPESSORE 3MM. NELLA CONFEZIONE È INOLTRE INCLUSO IL CABLAGGIO PER CONNETTERE LA LUCE TARGA E LE FRECCE ALL'IMPIANTO DELLA MOTO. IL KIT DI MONTAGGIO INCLUSO COMPRENDE TUTTI I COMPONENTI NECESSARI PER IL MONTAGGIO. VIENE FORNITA ANCHE UNA PIASTRINA IN ACCIAIO PER COPRIRE IL FORO LASCIATO SOTTO IL CODONE DAL PORTATARGA DI SERIE.

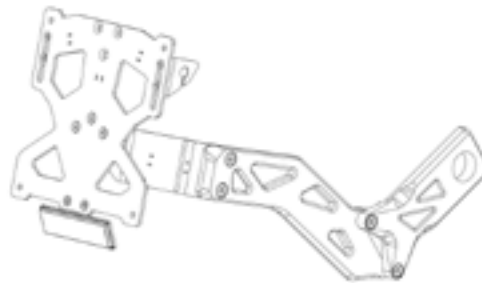

00
BLACK - NERO

Model - Modello	Year - Anno	Code - Codice
DUCATI		
MONSTER 797	17-22	PRTR021
SCRAMBLER	15-18	PRTR010
HONDA		
CBR 650 R	19-22	PRTR020
CB 650 R	19-22	PRTR020
MV AGUSTA		
TURISMO VELOCE	14-18	PRTR016
B3	11-22	PRTR017
DRAGSTER	14-22	PRTR016
RIVALE	13-18	PRTR016
STRADALE	13-18	PRTR016
BRUTALE 1000 RR	19-22	PRTR019
KAWASAKI		
Z 1000 SX	10-18	PRTR008
Z 650	17-22	PRTR013
Z 800	13-16	PRTR004
Z 900	17-22	PRTR011
Z 1000	14-20	PRTR005
SUZUKI		
SV 650	16-18	PRTR006
GSX -S750	17-20	PRTR012
GSX -S1000	15-22	PRTR001
YAMAHA		
MT 09 TRACER	15-17	PRTR007
MT 07	14-17	PRTR002
MT 09	13-16	PRTR003
	17-19	PRTR018
MT 10	16-22	PRTR009

FOREIGN 'KING' LICENSE PLATE HOLDER

PORTATARGA 'KING' ESTERO

Model - Modello	Year - Anno	Code - Codice	Code - Codice	Code - Codice	Code - Codice	Code - Codice	Code - Codice
		Switzerland	Germany	Spain	France	Japan	Netherlands
DUCATI							
MONSTER 797	17-22	PRTR021 CH	PRTR021 DE	PRTR021 E	PRTR021 F	PRTR021 J	PRTR021 NL
SCRAMBLER	15-18	PRTR010 CH	PRTR010 DE	PRTR010 E	PRTR010 F	PRTR010 J	PRTR010 NL
HONDA							
CBR 650 R	19-22	PRTR020 CH	PRTR020 DE	PRTR020 E	PRTR020 F	PRTR020 J	PRTR020 NL
CB 650 R	19-22	PRTR020 CH	PRTR020 DE	PRTR020 E	PRTR020 F	PRTR020 J	PRTR020 NL
MV AGUSTA							
TURISMO VE- LOCE	14-18	PRTR016 CH	PRTR016 DE	PRTR016 E	PRTR016 F	PRTR016 J	PRTR016 NL
B3	11-22	PRTR017 CH	PRTR017 DE	PRTR017 E	PRTR017 F	PRTR017 J	PRTR017 NL
DRAGSTER	14-22	PRTR016 CH	PRTR016 DE	PRTR016 E	PRTR016 F	PRTR016 J	PRTR016 NL
RIVALE	13-18	PRTR016 CH	PRTR016 DE	PRTR016 E	PRTR016 F	PRTR016 J	PRTR016 NL
STRADALE	13-18	PRTR016 CH	PRTR016 DE	PRTR016 E	PRTR016 F	PRTR016 J	PRTR016 NL
BRUTALE 1000 RR	19-22	PRTR019 CH	PRTR019 DE	PRTR019 E	PRTR019 F	PRTR019 J	PRTR019 NL
KAWASAKI							
Z 1000 SX	10-18	PRTR008 CH	PRTR008	PRTR008 E	PRTR008 F	PRTR008 J	PRTR008 NL
Z 650	17-22	PRTR013 CH	PRTR013	PRTR013 E	PRTR013 F	PRTR013 J	PRTR013 NL
Z 800	13-16	PRTR004 CH	PRTR004	PRTR004 E	PRTR004 F	PRTR004 J	PRTR004 NL
Z 900	17-22	PRTR011 CH	PRTR011	PRTR011 E	PRTR011 F	PRTR011 J	PRTR011 NL
Z 1000	14-20	PRTR005 CH	PRTR005	PRTR005 E	PRTR005 F	PRTR005 J	PRTR005 NL
SUZUKI							
SV 650	16-18	PRTR006 CH	PRTR006 DE	PRTR006 E	PRTR006 F	PRTR006 J	PRTR006 NL
GSX -S750	17-20	PRTR012 CH	PRTR012 DE	PRTR012 E	PRTR012 F	PRTR012 J	PRTR012 NL
GSX -S1000	15-22	PRTR001 CH	PRTR001 DE	PRTR001 E	PRTR001 F	PRTR001 J	PRTR001 NL
YAMAHA							
MT 09 TRACER	15-17	PRTR007 CH	PRTR007 DE	PRTR007 E	PRTR007 F	PRTR007 J	PRTR007 NL
MT 07	14-17	PRTR002 CH	PRTR002 DE	PRTR002 E	PRTR002 F	PRTR002 J	PRTR002 NL
MT 09	13-16	PRTR003 CH	PRTR003 DE	PRTR003 E	PRTR003 F	PRTR003 J	PRTR003 NL
	17-19	PRTR018 CH	PRTR018 DE	PRTR018 E	PRTR018 F	PRTR018 J	PRTR018 NL
MT 10	16-22	PRTR009 CH	PRTR009 DE	PRTR009 E	PRTR009 F	PRTR009 J	PRTR009 NL

LICENSE PLATE HOLDER ACCESSORIES

ACCESSORI PORTATARGA



LED LIGHT FOR 45MM FIX HOLES
LUCE TARGA LED - INTERASSE FORI 45MM

PRTL02

96



ALU LED LIGHT FOR 45MM FIX HOLES
LUCE TARGA LED ALLUMINIO - INTERASSE FORI 45MM

PRTL03

00 BLACK - NERO 02 BLUE - BLU 03 GOLD - ORO 04 RED - ROSSO 05 TITANIUM 07 GREEN - VERDE 16 ORANGE - ARANCIONE



REAR LED LIGHT SMOKED LENS WITH LICENSE LIGHT
LUCE LED POSTERIORE FUMÈ CON LUCE TARGA

AR57

97

SPARE PARTS



CONICAL SPACER HOLE 6
Distanziale conico foro 6

ACV018 6



PLATE REFLEX REFLECTOR
CATADIOTTRO

PRTSC01

00 BLACK - NERO 02 BLUE - BLU 03 GOLD - ORO 04 RED - ROSSO 05 TITANIUM 07 GREEN - VERDE 16 ORANGE - ARANCIONE

FRAME PROTECTORS



FRAME PROTECTORS 'EASY'

PARATELAI 'EASY'



'EASY' FRAME PROTECTORS
PARATELAI ALLUMINIO 'EASY'

RPT04

PERFECT FOR A BETTER LOOK GETTING A STRONG FRAME PROTECTION. ENTIRELY MADE WITH CNC MACHINERY IN ALUMINUM ALLOY. RECOMMENDED FOR DAILY STREET USE.

LE PROTEZIONI TELAIO SONO PERFETTE PER MIGLIORARE L'ESTETICA OFFRENDO UN'OTTIMA PROTEZIONE. SONO REALIZZATE IN ALLUMINIO LAVORATO CON MACCHINE A CONTROLLO NUMERICO CNC. CONSIGLIATA PER UN UTILIZZO STRADALE QUOTIDIANO.



00	02	03	04	05	07	16
BLACK - NERO	BLUE - BLU	GOLD - ORO	RED - ROSSO	TITANIUM	GREEN - VERDE	ORANGE - ARANCIONE



FRAME PROTECTORS 'TRACK'

PARATELAI 'TRACK'



'TRACK' ALU-NYLON FRAME PROTECTORS
PARATELAI ALLUMINIO-NYLON 'TRACK'

RPT02

THE NEW FRAME PROTECTORS OF EASY LINE OFFERS EXCELLENT PROTECTION BY MINIMIZING THE POSSIBLE DAMAGE TO THE FRAME DUE TO SHOCKS OR FALLS. IT IS MADE IN ALUMINUM AND NYLON, AVAILABLE IN DIFFERENT COLORS, CONFER A CONSIDERABLE AESTHETIC IMPACT AND A UNIQUE STYLE.

IL NUOVO PARATELAI DELLA LINEA EASY OFFRE UN'OTTIMA PROTEZIONE RIDUCENDO AL MINIMO I POSSIBILI DANNI AL TELAIO DOVUTI A URTI O CADUTE. È REALIZZATO IN ALLUMINIO E LE GHIERE, DISPONIBILI IN DIVERSI COLORI, CONFERISCONO UN NOTEVOLE IMPATTO ESTETICO E UNO STILE UNICO.

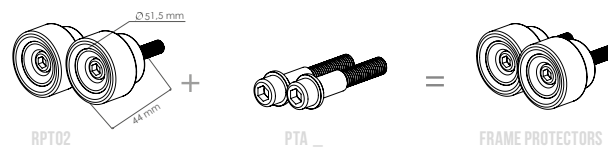

00	02	03	04	05	07	16
BLACK - NERO	BLUE - BLU	GOLD - ORO	RED - ROSSO	TITANIUM	GREEN - VERDE	ORANGE - ARANCIONE



VALTER MOTO COMPONENTS
Just racing parts

FRAME PROTECTORS 'NYLON TRACK'

PARATELAI 'NYLON TRACK'



'NYLON TRACK' FRAME PROTECTORS
PARATELAI 'NYLON TRACK'

RPT02N

TWO DIFFERENT MATERIALS IS THE TRIKING NOTE OF THIS PRODUCT DEVELOPED MAINLY FOR RACING USE. OUTSIDE COVER: SPECIAL POLYMER TO REDUCE IMPACT AND SLIDING. INSIDE CORE: MADE WITH CNC MACHINERY IN NYLON WICH GIVES THESE SLIDERS A SECOND HARD PROTECTION.

LE PROTEZIONI TELAIIO TRACK-NYLON SONO REALIZZATE CON DUE DIVERSI MATERIALI PER UN UTILIZZO PREVALENTEMENTE PISTA. LA PARTE ESTERNA È COMPOSTA DA UN POLIMERO DI COLORE NERO CHE ASSORBE L'IMPATTO E RALLENTA LO SCIVOLAMENTO. LA PARTE INTERNA CHE HA LA FUNZIONE DI SECONDA PROTEZIONE È IN NYLON LAVORATO CON MACCHINE A CONTROLLO NUMERICO CNC.

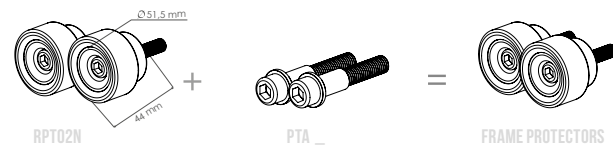

00
BLACK - NERO

Model - Modello	Year - Anno	Code - Codice
APRILIA		
RSV4/R/APRC	09-22	PTA62
TUONO V4	11-22	PTA62
BMW		
S 1000 RR	09-11	PTA64
S 1000 RR / HP4	12-14	PTA73
	15-18	PTA64
F 800 R	09-14	PTA67
DUCATI		
DIAVEL	14-15	PTA80
SCRAMBLER	15-18	PTA84
HONDA		
CBR 600 F	99-06	PTA13
	11-13	PTA70
CBR 600 RR	05-06	PTA16*
	07-08	PTA37
	09-12	PTA58
	13-16	PTA75*
CBR 650 R	19-22	PTA96
CBR 1000 RR	04-05	PTA19
	06-07	PTA32*
	08-16	PTA45*
HORNET 600	98-06	PTA06
	07-13	PTA40
CB 650 R	19-22	PTA96
CB 1000 R	08-22	PTA48
KAWASAKI		
ZX 250 R	07-13	PTA55
ZX 6-636 R/RR	05-06	PTA23*
	07-08	PTA35
	09-12	PTA52
	13-22	PTA76
ZX 10 R	04-05	PTA17*
	06-07	PTA30
	08-10	PTA42
	11-22	PTA68

Model - Modello	Year - Anno	Code - Codice
Z 1000 SX	10-16	PTA72
ZZR 1400 R	06-18	PTA50
ER6N	05-08	PTA27
	09-11	PTA57
	12-16	PTA83
Z 650	17-22	PTA87
Z 750 / R	07-13	PTA39
Z 800 / R	13-16	PTA74
Z 900	17-22	PTA85
Z 1000	07-09	PTA39
	10-18	PTA63
KTM		
SUPERDUKE 1290	14-19	PTA91
MV AGUSTA		
TURISMO VELOCE	14-22	PTA90
DRAGSTER (EURO 3)	14-15	PTA89
DRAGSTER (EURO 4)	16-20	PTA90
DRAGSTER (EURO 5)	21-22	PTA94
DRAGSTER (EURO 5) (*TOGLIERE COVER X SUONO EURO5)	21-22	PTA90
B3 (EURO 3)	13-15	PTA89
B3 (EURO 4)	16-20	PTA90
B3 (EURO 5)	21-22	PTA94
B3 (EURO 5) (*TOGLIERE COVER X SUONO EURO5)	21-22	PTA90
RIVALE	13-18	PTA89
BRUTALE 1000	19-22	PTA95
SUZUKI		
GSX 600 R / 750 R	04-05	PTA20
	06-07	PTA28
	08-10	PTA46
	11-17	PTA69
GSX 1000 R	03-04	PTA10
	05-06	PTA25
	07-08	PTA38
	09-16	PTA54*
GSX 1300R HAYABUSA	08-17	PTA49*
GSX -S125	17-21	PTA93

Model - Modello	Year - Anno	Code - Codice
GSR 600	06-12	PTA33
GLADIUS 650	09-15	PTA65
SV 650 /ABS	16-22	PTA82
GSR 750	10-16	PTA33
GSX -S750	17-20	PTA86
GSX -S1000 -950	15-22	PTA81
GSX S1000 GT	2022	PTA97
B-KING	07-12	PTA56
YAMAHA		
R6	03-05	PTA08*
	06-07	PTA29
	08-16	PTA43
	17-22	PTA88
R1	02-03	PTA02
	04-06	PTA18
	07-08	PTA36
	09-14	PTA51
	15-22	PTA79
TDM 900	02-14	PTA60
XJ6	09-15	PTA61
FZ6	04-11	PTA22
FZ8	10-16	PTA34
FZ1	06-15	PTA34
MT07/ ABS	14-17	PTA78
MT09 / ABS	13-16	PTA77
	17-22	PTA92
MT10	16-22	PTA79
TRIUMPH		
STREET TRIPLE / R	07-16	PTA41
SPEED TRIPLE / R	08-10	PTA47

*DRILL FAIRING - FORARE LA CARENA

'STREET' LEVER



'STREET' LEVER

LEVE 'STREET'



108

THE ADJUSTABLE STREET LEVERS HAVE BEEN DEVELOPED TO OFFER GREATER REGULATION ACCORDING TO DIFFERENT RIDING STYLES. IN ADDITION TO THE LEVER-GRIP DISTANCE CONTROL SYSTEM, WITH HIGHER POSITION FOR INCREASED ACCESSIBILITY, A SLIDING CONTROL SYSTEM ALLOWS THE LENGTH OF THE LEVER TO BE ADJUSTED.

LE LEVE REGOLABILI STREET SONO STATE PROGETTATE PER OFFRIRE UNA MAGGIOR REGOLAZIONE IN BASE AL PROPRIO STILE DI GUIDA. IN PARTICOLARE, OLTRE AL SISTEMA DI CONTROLLO DELLA DISTANZA LEVA-MANOPOLA, POSIZIONATO SUPERIORMENTE PER PERMETTERE UNA MAGGIORE ACCESSIBILITÀ, È STATO PREDISPOSTO UN SISTEMA AGGIUNTIVO A SCORRIMENTO CHE PERMETTE LA REGOLAZIONE IN LUNGHEZZA DELLA LEVA STESSA.

00	02	03	04
BLACK - NERO	BLUE - BLU	GOLD - ORO	RED - ROSSO



LENGHT ADJUSTMENT
REGOLAZIONE IN LUNGHEZZA

LEVER/GRIPS DISTANCE ADJUSTMENT
REGOLAZIONE DISTANZA LEVA/MANOPOLA

CLUTCH LEVER

LEVE FRIZIONE

Model - Modello	Year - Anno	Code - Codice
APRILIA		
TUONO V4	11-20	LSC11
DUCATI		
MULTISTRADA 1200	10-20	LSC14
MONSTER S4R	01-08	LSC14
MONSTER 1100	09-13	LSC14
STREET FIGHTER /S	09-13	LSC14
STREET FIGHTER 848	11-15	LSC14
DIAVEL	11-18	LSC14
HONDA		
AFRICA TWIN	17-20	LSC22
CB 650 R	19-22	LSC21
KAWASAKI		
Z 1000 SX	10-18	LSC12
Z 750 R	10-13	LSC12
Z 1000	14-18	LSC12
MV AGUSTA		
TURISMO VELOCE	14-22	LSC23
B3	12-22	LSC23
DRAGSTER	12-22	LSC23
BRUTALE 1000	19-22	LSC20
SUZUKI		
VSTROM 1000	17-19	LSC19
GSX -S1000	15-19	LSC11

Model - Modello	Year - Anno	Code - Codice
APRILIA		
TUONO V4	11-20	LSB03
DUCATI		
MULTISTRADA 1200	10-20	LSB03
MONSTER S4R	01-08	LSB03
MONSTER 1100	09-13	LSB03
STREET FIGHTER /S	09-13	LSB03
STREET FIGHTER 848	11-15	LSB03
DIAVEL	11-18	LSB03
HONDA		
AFRICA TWIN	17-20	LSB21
CB 650 R	19-22	LSB21
KAWASAKI		
Z 1000 SX	10-18	LSB02
Z 750 R	10-13	LSB02
Z 1000	14-18	LSB01
MV AGUSTA		
TURISMO VELOCE	14-22	LSB23
B3	12-22	LSB23
DRAGSTER	12-22	LSB23
BRUTALE 1000	19-22	LSB20
SUZUKI		
VSTROM 1000	17-19	LSB19
GSX -S1000	15-19	LSB01

WHEEL AXLE SLIDERS

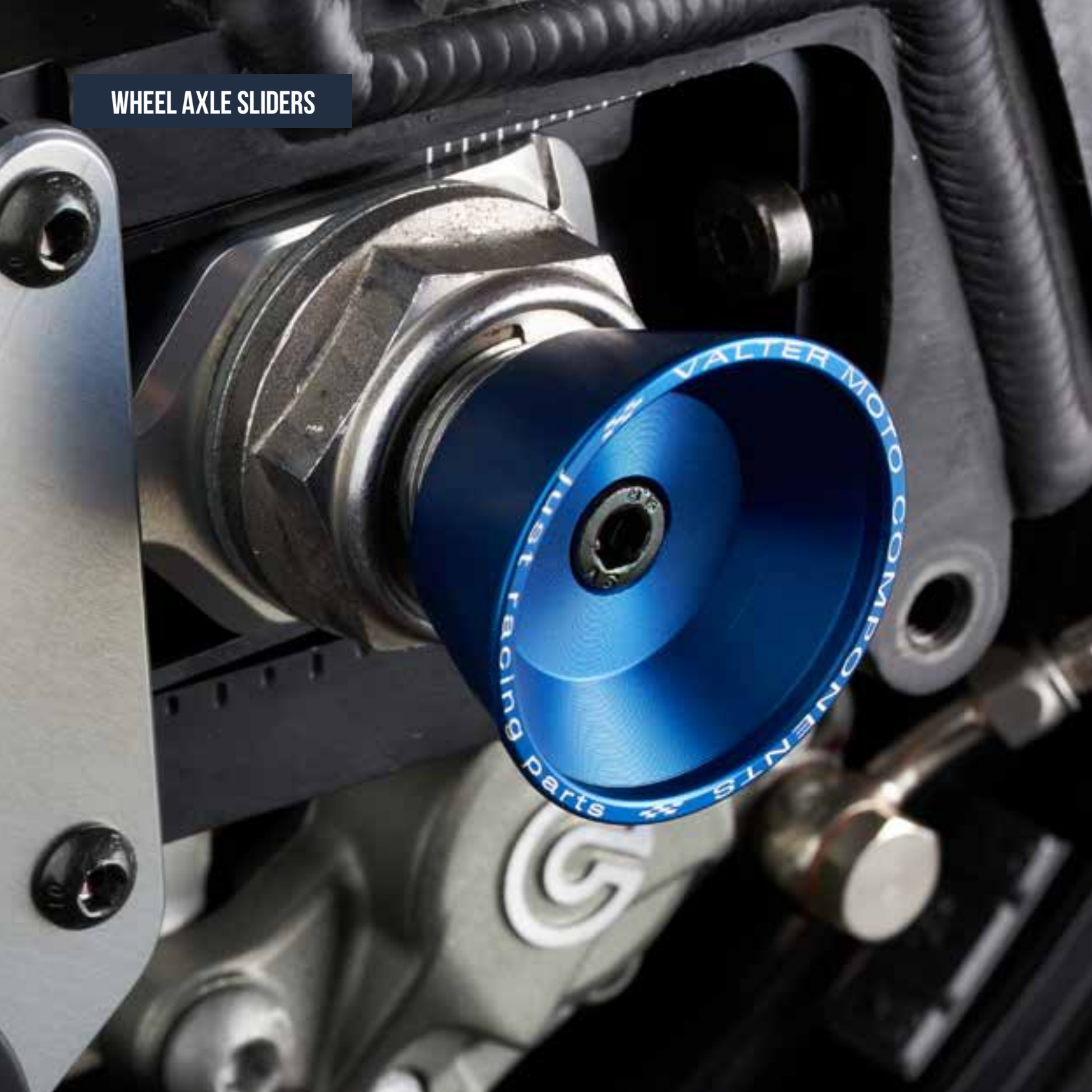

WHEEL AXLE SLIDERS

PROTEZIONI PERNO RUOTA



WHEEL AXLE SLIDERS
PROTEZIONI PERNO RUOTA

CPC01

WHEEL AXLE SLIDERS
PROTEZIONI PERNO RUOTA

CPC02

ENTIRELY MADE WITH CNC MACHINERY IN ALUMINUM ALLOY. PERFECT FOR A BIKES BETTER LOOKING GIVING AN OPTIMAL WHEEL AXLE PROTECTION. USED TO REMOVE THE WHEEL PIVOT THANKS TO ERGONOMIC HANDGRIP. THEY FIT PERFECTLY ON THE BIKE, RECOMMENDED FOR BOTH STREET AND RACING USE.

INTERAMENTE REALIZZATI IN ALLUMINIO RICAVATI DAL PIENO. MIGLIORANO L'ESTETICA DELLA MOTO E SONO PERFETTI COME PROTEZIONE. UTILIZZABILI PER L'ESTRAZIONE DEL PERNO RUOTA, GRAZIE ALLA FORMA ERGONOMICA. QUESTE PROTEZIONI SONO CONSIGLIATE PER UN USO SIA SU STRADA CHE IN PISTA.

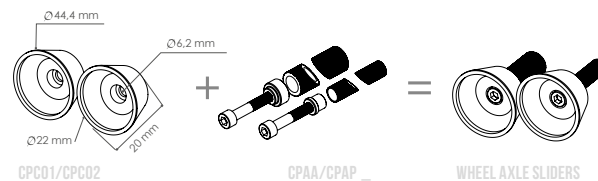

00 BLACK - NERO 02 BLUE - BLU 03 GOLD - ORO 04 RED - ROSSO 05 TITANIUM 07 GREEN - VERDE 16 ORANGE - ARANCIONE



Model - Modello	Year - Anno	Code - Codice		Code - Codice	
		Front Sliders	Front Kit	Rear Sliders	Rear Kit
APRILIA					
RSV4/R/APRC	09-22	CPC01	CPAAD01	CPC01	CPAPA01
TUONO V4	11-22	CPC01	CPAAD01	CPC01	CPAPA01
BMW					
S 1000 RR	09-18	CPC01	CPAAB01	CPC01	CPAPB01
	19-22			CPC01	CPAPS01
	19-22	CPC01	CPAAB01		
F 800 R	09-14	CPC01	CPAAB02		
DUCATI					
749 / 999	03-06	CPC01	CPAAD01	CPC01	CPAPD01
MONSTER 696 / 796	08-14	CPC01	CPAAD01	CPC01	CPAPD02
MONSTER S4R / S2R	01-08	CPC01	CPAAD01	CPC01	CPAPD02
DIAVEL	14-15	CPC01	CPAAD03		
SCRAMBLER	15-18	CPC01	CPAAD04	CPC01	CPAPD04
HONDA					
CBR 600 F	11-13	CPC02	CPAAH02		
CBR 600 R / RR	05-08	CPC02	CPAAH02	CPC01	CPAPH02
	09-12	CPC02	CPAAH04		
	13-16	CPC02	CPAAH05	CPC01	CPAPH01
CBR 650 R	19-22	CPC02	CPAAH07		
CBR 1000 R / RR	04-07	CPC02	CPAAH01	CPC01	CPAPH01
	08-16	CPC02	CPAAH03	CPC01	CPAPH01
	17-19	CPC02	CPAAH06	CPC01	CPAPH06
	20-22	CPC02	CPAAH08	CPC01	CPAPH08
	19-22	CPC02	CPAAH07		
CB 650 R	19-22	CPC02	CPAAH07		
CB 1000 R	08-17	CPC02	CPAAH02		
KAWASAKI					
ZX 6-636 R/RR	03-12	CPC01	CPAAK02	CPC01	CPAPK02
	13-17	CPC01	CPAAK06	CPC01	CPAPK02
ZX 10 R	06-07	CPC01	CPAAK03	CPC01	CPAPK03
	08-10	CPC01	CPAAK04	CPC01	CPAPK03
	11-15	CPC01	CPAAK07	CPC01	CPAPK02
	16-22	CPC01	CPAAK08	CPC01	CPAPK02
ZZR 1400 R	06-18	CPC01	CPAAK02	CPC01	CPAPK02
Z 650	17-22	CPC01	CPAAK10	CPC01	CPAPK03
Z 800 / R	13-16	CPC01	CPAAK05		
Z 900	17-22	CPC01	CPAAK09	CPC01	CPAPK09
Z 1000 / SX	07-09	CPC01	CPAAK01	CPC01	CPAPK01
	13-18	CPC01	CPAAK05		

Model - Modello	Year - Anno	Code - Codice		Code - Codice	
KTM					
SUPERDUKE 1290	14-18	CPC01	CPAAO01		
MV AGUSTA					
F3	11-22	CPC01	CPAAM01		
F4	10-18	CPC01	CPAAM02		
TURISMO VELOCE	14-22	CPC01	CPAAM01		
DRAGSTER	14-22	CPC01	CPAAM01		
B3	11-22	CPC01	CPAAM01		
BRUTALE 1000	19-22	CPC01	CPAAM03		
RIVALE	13-18	CPC01	CPAAM01		
SUZUKI					
GSX 600 / 750 R	06-10	CPC02	CPAAS01	CPC01	CPAPS01
	11-17	CPC01	CPAAS03	CPC01	CPAPS03
GSX 1000 R	05-11	CPC02	CPAAS01	CPC01	CPAPS01
	12-16	CPC01	CPAAS04	CPC01	CPAPS01
	17-22	CPC01	CPAAS07	CPC01	CPAPS07
GSX 1300R HAYABUSA	08-17	CPC02	CPAAS01	CPC01	CPAPS02
V STROM 1000	16-19	CPC01	CPAAS04	CPC01	CPAAS04
GSR 750	12-16	CPC01	CPAAS02		
GSX -S750	17-20	CPC01	CPAAS06	CPC01	CPAPS06
GSX -S1000 -950	15-22	CPC01	CPAAS05	CPC01	CPAPS05
B-KING	07-12	CPC02	CPAAS01	CPC01	CPAPS01
YAMAHA					
R6	03-16	CPC02	CPAAY01	CPC01	CPAPY01
	17-22	CPC01	CPAAY06	CPC01	CPAPY06
R1	04-14	CPC02	CPAAY01	CPC01	CPAPY01
	15-22	CPC01	CPAAY06	CPC01	CPAPY06
TDM 900	02-14	CPC01	CPAAY02	CPC01	CPAPY01
MT07	14-17	CPC01	CPAAY05		
MT09	13-16	CPC01	CPAAY03	CPC01	CPAPY04
	17-22	CPC01	CPAAY03		
MT10	16-22	CPC01	CPAAY07	CPC01	CPAPY07
T-MAX	08-11	CPC01	CPAAY02		
	12-16	CPC01	CPAAY02		

FLUID COVERS



BRAKE AND CLUTCH FLUID COVERS

COPERCHI SERBATOI OLIO FRENO-FRIZIONE



DESIGNED BY VMC AND ENTIRELY MADE WITH CNC MACHINERY IN ALUMINUM ALLOY IS A PERFECT REPLACEMENT TO THE OEM CAP TO ENRICH BIKE LOOK.

PROGETTATO DA VMC ED INTERAMENTE REALIZZATO IN ALLUMINIO RICAVATO DAL PIENO LAVORATO CON MACCHINE CNC, È PERFETTO PER SOSTITUIRE IL COPERCHIO DI SERIE.

00	02	03	04	07
BLACK - NERO	BLUE - BLU	GOLD - ORO	RED - ROSSO	GREEN - VERDE ONLY KAWASAKI

Model - Modello	Year - Anno	Code - Codice	Code - Codice	Code - Codice
		FRONT	REAR	CLUTCH
APRILIA				
RSV4/R/APRC	09-22	CSA01	not available	not available
TUONO V4	11-22	CSA01	not available	not available
BMW				
S 1000 RR / HP4	09-18	CSA02	CSR03	not available
	19-22	CSA02		
F 800 R	09-14	CSA04	CSR02	not available
DUCATI				
748 / 916 / 996 / 998	93-03	CSA01	CSR02	CSR02
749 / 999	03-06	CSA01	CSR02	CSR02
848	08-13	CSA01	CSR02	CSR02
1098/1198	07-11	CSA01	CSR02	CSR02
PANIGALE 899	14-15	CSA01	CSR02	CSR02
PANIGALE 1199 / 1299	12-18	CSA01	CSR02	CSR02
PANIGALE V2	21-22	CSA01	CSR08	CSR08
PANIGALE V4	18-22	CSA01	CSR02	CSR02
MONSTER 696 / 796	08-15	CSA01	CSR02	CSR02
MONSTER S4R / S2R	01-08	CSA01	CSR02	CSR02
MONSTER 1100	09-13	CSA01	CSR02	CSR02
STREETFIGHTER	09-15	CSA01	CSR02	CSR02
MULTISTRADA 1200	10-19	CSA01	CSR02	CSR02
SCRAMBLER	15-18	not available	CSR02	not available
HONDA				
CBR 600 RR / ABS	07-16	CSA02	not available	not available
CBR 650 R	19-22	CSA14	not available	not available
CBR 1000 RR	06-07	CSA02	not available	CSR01
	08-18	CSA02	CSR01	not available
	20-22	CAS01	CSR07	
X-ADV	17-22	CSA14	not available	CSA14
AFRICA TWIN	17-19	CSA14	not available	CSR07

Model - Modello	Year - Anno	Code - Codice	Code - Codice	Code - Codice
CB 650 R	19-22	CSA14	not available	not available
CB 1000 R	08-10	CSA02	CSR01	CSR01
	11-17	CSA02	CSA02	CSR01
KAWASAKI				
NINJA 400	18-22	not available	CSR01	not available
ZX6R	03-06	CSA02	not available	not available
	07-08	CSA02	CSR01	not available
	09-22	CSA02	CSR04	not available
ZX 10 R	04-05	CSA02	not available	not available
	06-07	CSA02	CSA02	not available
	08-15	CSA02	CSR01	not available
	16-22	CSA01	CSR06	not available
Z 1000 SX	07-18	CSA02	CSR01	not available
ER6N	05-08	not available	CSA02	not available
ER6F	06-08	not available	CSA02	not available
Z 650	17-22	CSA05	not available	not available
Z 750 / R / ABS	07-13	CSA02	CSR01	not available
Z 800	13-16	CSA05	CSR01	not available
Z 900	17-22	CSA05	CSR01	not available
Z 1000	10-18	CSA06	CSR01	not available
KTM				
SUPERDUKE 1290	14-21	CSA01	CSR02	CSR01
MV AGUSTA				
F3	11-22	CSA02	not available	not available
F4	10-18	CSA13	not available	CSR05
TURISMO VELOCE	14-22	CSR05	CSR07	CSA13
B3	16-22	CSA13	CSR07	CSR05
BRUTALE 1000	19-22	CSA01	CSR08	CSR08
SUZUKI				
GSX 600 R / GSX 750 R	06-10	CSA02	not available	not available
	11-17	CSA02	CSR01	not available

Model - Modello	Year - Anno	Code - Codice	Code - Codice	Code - Codice
GSX 1000 R	01-16	CSA02	not available	not available
	07-08	CSA02	not available	CSR01
	09-16	CSA02	not available	not available
	17-22	CSA02	CSR02	not available
V STROM 1000	16-19	CSA10	CSA10	CSR07
GSX -S125	17-22	not available	CSA01	not available
SV 650	16-22	CSA10	not available	not available
GSX -S750	17-20	CSA10	not available	not available
GSX -S1000 -950	15-22	CSA12	not available	not available
YAMAHA				
R6	03-05	CSA02	not available	not available
	06-16	CSA02	CSR01	not available
	17-22	CSA11	CSR01	not available
R1	00-08	CSA02	not available	not available
	09-15	CSA02	CSR01	not available
	16-22	CSA11	CSR04	not available
XJ6	08-15	CSA07	not available	not available
FZ6	04-06	CSA07	not available	not available
FZ8	10-15	CSA07	not available	not available
FZ1	06-15	CSA07	not available	not available
MT07	14-17	CSA09	CSR01	not available
MT09	13-22	CSA07	CSR01	not available
MT10	16-22	CSA09	CSR01	not available
TRIUMPH				
DAYTONA 675	07-12	CSA02	CSR01	not available
	13-16	CSA01	CSR01	not available
STREET TRIPLE 675/ R	07-16	CSA02	CSR01	not available
	17-21	CSA01	CSR01	not available
SPEED TRIPLE / R	05-10	CSA02	not available	not available
	11-18	CSA01	CSR01	not available

OIL TANK 'STREET'



OIL TANK 'STREET'

SERBATOIO OLIO 'STREET'



FRONT BRAKE OIL TANK
SERBATOIO OLIO FRENO ANTERIORE

SOF04B

THIS OIL TANK IS ENTIRELY MADE IN ALUMINUM ALLOY CNC MACHINED TO HAVE THE PRODUCT BEST QUALITY. MADE ON A VMC DESIGN IS AVAILABLE IN BLACK WITH COLORED INSERTS. ON ONE SIDE THERE'S THE OIL LEVEL CHECK WINDOW. TWO DIFFERENT EXIT TUBE CONNECTIONS, ONE LATERAL AND ONE ON THE BOTTOM.

SERBATOIO OLIO È INTERAMENTE REALIZZATO IN LEGA DI ALLUMINIO LAVORATA CON CENTRI DI LAVORO CNC PER GARANTIRE LA MASSIMA QUALITÀ. PROGETTATO SU UN DESIGN PERSONALIZZATO VMC VIENE PROPOSTO NERO CON INSERTI COLORATI. SUL LATO È PRESENTE LA FINESTRA PER IL CONTROLLO DEL LIVELLO DELL'OLIO. IL SERBATOIO È DOTATO DI DUE POSSIBILITÀ DI USCITA DEL TUBO DELL'OLIO, UNA LATERALE ED UNA INFERIORE.



CLUTCH BRAKE OIL TANK
SERBATOIO OLIO FRIZIONE

SOF04C



STEM NUT



STEM NUT

DADO CANNOTTO



DESIGNED BY VMC AND ENTIRELY MADE WITH CNC MACHINERY IN ALUMINUM ALLOY IS A PERFECT REPLACEMENT TO THE OEM CAP TO ENRICH BIKE LOOK. EASY TO FIX.

PROGETTATO DA VMC ED INTERAMENTE REALIZZATO IN ALLUMINIO RICAVATO DAL PIENO LAVORATO CON MACCHINE CNC, È PERFETTO PER SOSTITUIRE IL DADO CANNOTTO DI SERIE. MONTAGGIO FACILE.

00	02	03	04	07
BLACK - NERO	BLUE - BLU	GOLD - ORO	RED - ROSSO	GREEN - VERDE ONLY KAWASAKI

Model - Modello	Year - Anno	Code - Codice
BMW		
S 1000 RR / HP4	09-18	DC01
HONDA		
CBR 600 F	95-13	DC05
CBR 600 R / RR / ABS	03-16	DC05
CBR 650 R	19-22	DC05
CBR 1000 R / RR / ABS	04-07	DC05
HORNET 600	98-13	DC05
CB 650 R	19-22	DC05
CB 1000 R	08-17	DC05
KAWASAKI		
NINJA 400	18-20	DC04
ZX 6-636 R / RR	98-02	DC02
	03-04	DC04
	06-18	DC01
ZX 9 R	98-05	DC02
ZX 10 R / ABS	04-22	DC01
ZZR 1400 R	06-18	DC04
SUZUKI		
GSX 600 / 750 R	00-05	DC03
	06-17	DC01
GSXS 750	17-18	DC02
GSX 1000 R	01-02	DC03
	03-18	DC01
GSX 1300R HAYABUSA	08-17	DC03
V STROM 1000	16-19	DC03
GSR 600	06-12	DC03
GLADIUS 650	09-15	DC02
SV650	16-22	DC02
GSR 750	10-16	DC02

Model - Modello	Year - Anno	Code - Codice
GSX -S1000 -950	15-22	DC01
B-KING	07-12	DC03
YAMAHA		
R125	08-18	DC02
R6	99-16	DC01
	17-22	DC01
R1	98-22	DC01
TDM 900	02-14	DC01
XJ6	09-15	DC02
FZ6	04-11	DC02
FZ8	10-16	DC01
FZ1	06-15	DC01
MT09	13-16	DC02
MT10	16-22	DC01
TRIUMPH		
DAYTONA 675 / R	06-16	DC04
STREET TRIPLE / R	07-17	DC04

Pitch - Passo	Code - Codice
Ø 28 x 1mm	DC01
Ø 22 x 1mm	DC02
Ø 24 x 1.5 mm	DC03
Ø 25 x 1mm	DC04
Ø 24 x 1mm	DC05

MIRROR HOLES COVERS



MIRROR HOLES COVERS

TAPPI FORI SPECCHIO



130

ENTIRELY MADE WITH CNC MACHINERY IN ALUMINUM ALLOY ARE THE PERFECT EQUIPMENT TO COVER HOLES WHEN MIRRORS ARE NOT MOUNTED. THEY FIT PERFECTLY ON ORIGINAL HOLES SO IT'S EASY TO INSTALL THEM.

INTERAMENTE REALIZZATI UTILIZZANDO ALLUMINIO AERONAUTICO LAVORATO SU CENTRI DI LAVORO A CONTROLLO NUMERICO CNC QUESTI COPERCHI SONO INDICATI PER COPRIRE GLI ALLOGGIAMENTI DEGLI SPECCHIETTI QUANDO VENGONO RIMOSI PER L'USO PISTA. LA FORMA È DEDICATA AL MODELLO DI MOTO E SONO DI FACILE FISSAGGIO.

00	02	03	04	07
BLACK - NERO	BLUE - BLU	GOLD - ORO	RED - ROSSO	GREEN - VERDE
				ONLY KAWASAKI

Model - Modello	Year - Anno	Code - Codice
APRILIA		
RSV4	17-21	TAS23
BMW		
S1000 RR	09-18	TAS11
DUCATI		
848	08-13	TAS13
1098	07-09	TAS13
1198	09-11	TAS13
PANIGALE V2	21-22	TAS24
PANIGALE V4	18-22	TAS22
HONDA		
CBR 600 F	01-13	TAS03
CBR 600 R/RR	03-16	TAS03
CBR 1000 R/RR	04-07	TAS03
	08-17	TAS20
KAWASAKI		
NINJA 400	18-22	TAS14
ZX 6-636 R / RR	05-08	TAS01
	09-12	TAS07
	13-21	TAS14
ZX 10 R /ABS	04-07	TAS01
	08-10	TAS02
	11-15	TAS12
	16-21	TAS16
Z 1000 SX	10-19	TAS01
MV AGUSTA		
F3	11-22	TAS18
F4	10-18	TAS21
SUZUKI		
GSX 600/750 R	06-17	TAS04
GSX 1000 R	05-16	TAS04
	17-22	TAS19
GSX 1300R HAYABUSA	08-17	TAS04
YAMAHA		
R125	08-18	TAS10
R6	99-05	TAS05
	06-07	TAS09
	08-16	TAS06
	17-20	TAS17
R1	98-08	TAS05
	09-14	TAS08
	15-19	TAS17

MIRRORS



HOMOLOGATED 'STREET' MIRROR

SPECCHIO 'STREET' OMOLOGATO



HOMOLOGATED 'STREET' MIRROR
SPECCHIO 'STREET' OMOLOGATO

SPX10



VMC STREET MIRROR IS A TOP QUALITY PRODUCT ENTIRELY MADE WITH ALUMINUM CNC MACHINED. IT IS CHARACTERIZED BY AN EXCLUSIVE VMC DESIGN. MEASURES ARE 120x85 MM AND 15 MM. THICKNESS. THIS PARTICULAR MIRROR IS DEVELOPED TO BE MOUNTED ON THE HANDLEBAR BY AN ALU ROD BILLET MADE. IT CAN BE MOUNTED BOTH ON THE LEFT OR RIGHT SIDE. IT IS EQUIPPED WITH A LIGHT SMOKE MIRROR FOR A BETTER DAYLIGHT VISION. THE MOUNTING KIT ALLOWS TO FIX IT ON ALL M10 RIGHT THREAD 1.25 HANDLEBARS HOLES. THIS MODEL OF MIRROR IS HOMOLOGATED E3 SO CAN BE USED ON PUBLIC ROADS.

LO SPECCHIETTO VMC STREET È UN PRODOTTO DI ALTA QUALITÀ REALIZZATO INTERAMENTE IN ALLUMINIO LAVORATO CON MACCHINARI CNC. QUESTO MODELLO DI SPECCHIO È CARATTERIZZATO DA UN DESIGN PERSONALIZZATO VMC MODERNO E RICERCATO. LE MISURE SONO 120x85 MM E 15 MM DI PROFONDITÀ. LO SPECCHIETTO È STATO SVILUPPATO PER IL MONTAGGIO AL MANUBRIO TRAMITE ASTA IN ALLUMINIO RICAVATA DAL PIENO. IL PRODOTTO È UNIVERSALE E PUÒ ESSERE INSTALLATO SIA SULLA DESTRA CHE SULLA SINISTRA. IL VETRO RIFLETTENTE UTILIZZATO È LEGGERMENTE FUMÈ PER GARANTIRE UNA BUONA VISIONE DIURNA. IL KIT DI MONTAGGIO INCLUSO PERMETTE IL MONTAGGIO SU TUTTI I MANUBRI CON FORO DI FISSAGGIO M10 PASSO 1.25. QUESTO MODELLO DI SPECCHIETTO È OMOLOGATO E3 QUINDI IDONEO PER L'UTILIZZO SU STRADA.

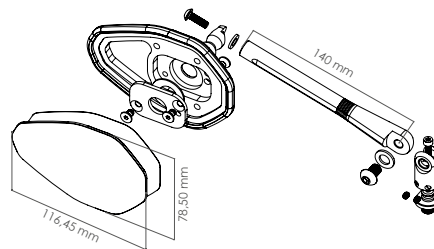

00 BLACK - NERO
01 ERGAL - BIANCO



SUZUKI
ELECTRO-GLASS

SUZUKI

HOMOLOGATED 'STREET-GRIPS' MIRROR

SPECCHIO 'STREET-GRIPS' OMOLOGATO



HOMOLOGATED 'STREET-GRIPS' MIRROR
SPECCHIO 'STREET-GRIPS' OMOLOGATO

SPX11

THIS NEW MIRROR WAS DEVELOPED WITH A NEW FIXING SYSTEM NEXT TO THE GRIP INSTEAD OF THE HANDLEBAR END. FIXING ARM AND MIRROR BODY ARE ENTIRELY MADE OF ALUMINUM CNC MACHINED. THE MIRROR GLASS HAS THE CORRECT DIMENSIONS AND IS CONVEX AS REQUESTED BY HOMOLOGATION. THE MIRROR CAN BE FIXED EITHER ON THE LEFT OR ON THE RIGHT SIDE OF THE HANDLEBAR. DEDICATED FIXING KIT IS SOLD SEPARATELY.

SPECCHIO SVILUPPATO CON SISTEMA DI FISSAGGIO ACCANTO ALLE MANOPOLE AL POSTO DEL TERMINALE MANUBRIO. BRACCIO DI FISSAGGIO E CORPO REALIZZATI IN ALLUMINIO LAVORATO CNC. VETRO SPECCHIO AZZURRATO E CONVESSO COME DA NORMATIVA. LO SPECCHIO PERMETTE IL MONTAGGIO INDIFFERENTEMENTE SULLA SINISTRA O SULLA DESTRA DEL MANUBRIO. GLI ATTACCHI SPECIFICI SONO VENDUTI SEPARATAMENTE.

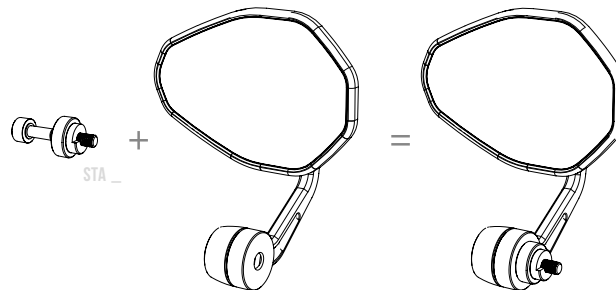

00 BLACK - NERO
01 ERGAL - BIANCO



VISUAL LINE 50

YAMAHA

'NAKED' MIRROR

SPECCHIO 'NAKED'



NAKED' LEFT MIRROR
SPECCHIO SINISTRO 'NAKED'

SPX01L

NAKED' RIGHT MIRROR
SPECCHIO DESTRO 'NAKED'

SPX01R

137

VMC NAKED MIRROR IS PART OF VMC, ENTIRELY MADE WITH ALUMINUM CNC MACHINED WITH A SPECIAL LIGHT WORKED STEM. IT IS CHARACTERIZED BY A SOPHISTICATED DESIGN. MEASURES ARE ABOUT 160x75 MM. IT IS CHARACTERIZED BY A SOPHISTICATED DESIGN. MEASURES ARE ABOUT 160x75 MM. IT IS EQUIPPED WITH A LIGHT SMOKE MIRROR FOR A BETTER DAYLIGHT VISION. THE MOUNTING KIT ALLOWS TO FIX IT ON THE RIGHT SIDE ONLY ON ALL 1,25 THREADED HOLES.

LO SPECCHIETTO VMC NAKED È INTERAMENTE RICAVATO DAL PIENO CON LAVORAZIONI OTTENUTE CON L'UTILIZZO DI MACCHINE A CONTROLLO NUMERICO CNC. IL CORPO DELLO SPECCHIO COSÌ COME LO STELO SONO STATI LAVORATI PER RIDURRE AL MINIMO IL PESO SENZA COMPROMETTERE LA ROBUSTEZZA. LO SPECCHIO NAKED È CARATTERIZZATO DAL DESIGN UNICO DI VMC. LE MISURE DI INGOMBRO DELLO SPECCHIO SONO 160x75 MM. IL VETRO SELEZIONATO HA UNA COLORAZIONE LEGGERMENTE FUMÈ PER GARANTIRE UNA VISIONE GIORNO/NOTTE OTTIMALE. IL KIT DI MONTAGGIO INCLUSO PERMETTE IL FISSAGGIO SU FORO CON FILETTO STANDARD PASSO 1,25.



00	02	03	04	07
BLACK - NERO	BLUE - BLU	GOLD - ORO	RED - ROSSO	GREEN - VERDE

'FLAT' MIRROR

SPECCHIO 'FLAT'



FLAT' MIRROR
SPECCHIO 'FLAT'

SPX08

VMC FLAT MIRROR IS A TOP QUALITY PRODUCT ENTIRELY MADE WITH ALUMINUM CNC MACHINED. IT IS CHARACTERIZED BY A MINIMALIST MODERN DESIGN. MEASURES ARE 130x65 MM AND 15 MM. THICKNESS. IT CAN BE MOUNTED BOTH ON THE LEFT OR RIGHT SIDE OF HANLEBAR. IT IS EQUIPPED WITH A LIGHT SMOKE MIRROR FOR A BETTER DAYLIGHT VISION. THE MOUNTING KIT ALLOWS TO FIX IT ON ALL 1.25 THREADED HOLES.

LO SPECCHIETTO VMC FLAT È UN PRODOTTO DI ALTA QUALITÀ REALIZZATO INTERAMENTE IN ALLUMINIO LAVORATO CON MACCHINARI CNC. QUESTO MODELLO DI SPECCHIO È CARATTERIZZATO DA UN DESIGN MODERNO E MINIMALISTA. LE MISURE SONO 130x65 MM E 15 MM DI PROFONDITÀ. IL PRODOTTO È UNIVERSALE E PUÒ ESSERE INSTALLATO SIA SULLA DESTRA CHE SULLA SINISTRA. IL VETRO RIFLETTENTE UTILIZZATO È LEGGERMENTE FUMÈ PER GARANTIRE UNA BUONA VISIONE DIURNA. IL KIT DI MONTAGGIO INCLUSO PERMETTE IL FISSAGGIO SU ALLOGGIAMENTI CON FORO PASSO 1.25.

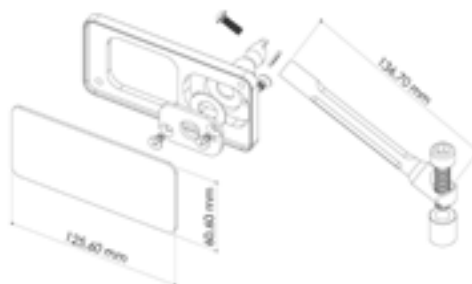

00	02	03	04	05	07	16
BLACK - NERO	BLUE - BLU	GOLD - ORO	RED - ROSSO	TITANIUM	GREEN - VERDE	ORANGE - ARANCIONE

'MINI' MIRRORS

SPECCHIO 'MINI'



MINI' MIRROR
SPECCHIO 'MINI'

SPX09

VMC MINI MIRROR IS A TOP QUALITY PRODUCT ENTIRELY MADE WITH ALUMINUM CNC MACHINED. IT IS CHARACTERIZED BY A MINIMALIST MODERN DESIGN. MEASURES ARE 90x55-65 MM AND 15 MM. THICKNESS. THIS PARTICULAR MIRROR IS DEVELOPED TO BE MOUNTED AT THE END OF THE HANDLEBAR NEAR GRIPS . IT CAN BE MOUNTED BOTH ON THE LEFT OR RIGHT SIDE. IT IS EQUIPPED WITH A LIGHT SMOKE MIRROR FOR A BETTER DAYLIGHT VISION. THE MOUNTIG KIT ALLOWS TO FIX IT ON ALL Ø13-16 HOLE HANDLEBARS.

LO SPECCHIETTO VMC MINI È UN PRODOTTO DI ALTA QUALITÀ REALIZZATO INTERAMENTE IN ALLUMINIO LAVORATO CON MACCHINARI CNC. QUESTO MODELLO DI SPECCHIO È CARATTERIZZATO DA UN DESIGN MODERNO E MINIMALISTA. LE MISURE SONO 90x55-65 MM E 15 MM DI PROFONDITÀ. QUESTO PARTICOLARE SPECCHIETTO È STATO SVILUPPATO PER IL MONTAGGIO ALLE ESTREMITÀ DEL MANUBRIO ACCANTO ALLE MANOPOLE. IL PRODOTTO È UNIVERSALE E PUÒ ESSERE INSTALLATO SIA SULLA DESTRA CHE SULLA SINISTRA. IL VETRO RIFLETTENTE UTILIZZATO È LEGGERMENTE FUMÈ PER GARANTIRE UNA BUONA VISIONE DIURNA. IL KIT DI MONTAGGIO INCLUSO PERMETTE IL MONTAGGIO SU TUTTI I MANUBRI CON FORO INTERNO Ø 13-16.



00 BLACK - NERO 02 BLUE - BLU 03 GOLD - ORO 04 RED - ROSSO 05 TITANIUM 07 GREEN - VERDE 16 ORANGE - ARANCIONE

HOMOLOGATED 'CIRCULAR' MIRROR

SPECCHIO 'CIRCULAR' OMOLOGATO



HOMOLOGATED 'CIRCULAR' MIRROR
SPECCHIO 'CIRCULAR' OMOLOGATO

SPX12

140

VMC CIRCULAR MIRROR IS A PRODUCT ENTIRELY MADE WITH ALUMINUM CNC MACHINED. IT IS CHARACTERIZED BY AN EXCLUSIVE VMC DESIGN. THE MEASURES ARE 101 MM (DIAMETER) AND 15 MM THICKNESS. THIS PARTICULAR MIRROR IS DEVELOPED TO BE MOUNTED ON THE HANDLEBAR BY AN ALU ROD BILLET MADE. IT CAN BE MOUNTED BOTH ON THE LEFT OR RIGHT SIDE. IT IS EQUIPPED WITH A LIGHT SMOKE MIRROR FOR A BETTER DAYLIGHT VISION. THE MOUNTING KIT ALLOWS TO FIX IT ON ALL M10 RIGHT THREAD 1,25 HANDLEBARS HOLES. THIS MODEL OF MIRROR IS HOMOLOGATED E3 SO CAN BE USED ON PUBLIC ROADS.

LO SPECCHIETTO CIRCULAR È UN PRODOTTO REALIZZATO INTERAMENTE IN ALLUMINIO LAVORATO CON MACCHINARI CNC. QUESTO MODELLO DI SPECCHIO È CARATTERIZZATO DA UN DESIGN PERSONALIZZATO VMC. LO SPECCHIETTO HA LE SEGUENTI MISURE: DIAMETRO 101MM E 29 MM DI PROFONDITÀ. È STATO SVILUPPATO PER IL MONTAGGIO AL MANUBRIO TRAMITE ASTA IN ALLUMINIO RICAVATA DAL PIENO. IL PRODOTTO È UNIVERSALE E PUÒ ESSERE INSTALLATO SIA SULLA DESTRA CHE SULLA SINISTRA. IL VETRO RIFLETTENTE UTILIZZATO È LEGGERMENTE FUMÈ PER GARANTIRE UNA BUONA VISIONE DIURNA. IL KIT DI MONTAGGIO INCLUSO PERMETTE IL MONTAGGIO SU TUTTI I MANUBRI CON FORO DI FISSAGGIO M10 PASSO 1,25 DX. QUESTO MODELLO DI SPECCHIETTO È OMOLOGATO E3 QUINDI IDONEO PER L'UTILIZZO SU STRADA.



00
BLACK - NERO

HOMOLOGATED 'CIRCULAR-GRIPS' MIRROR

SPECCHIO 'CIRCULAR-GRIPS' OMOLOGATO



HOMOLOGATED 'CIRCULAR-GRIPS' MIRROR
SPECCHIO 'CIRCULAR-GRIPS' OMOLOGATO

SPX13

CIRCULAR MIRROR WAS DEVELOPED WITH A NEW FIXING SYSTEM NEXT TO THE GRIP INSTEAD OF THE HANDLEBAR END. FIXING ARM AND MIRROR BODY ARE ENTIRELY MADE OF ALUMINUM CNC MACHINED. THE MIRROR GLASS HAS THE CORRECT DIMENSIONS AND IS CONVEX AS REQUESTED BY HOMOLOGATION. THE MEASURES ARE 101 MM (DIAMETER) AND 15 MM THICKNESS. THE MIRROR CAN BE FIXED EITHER ON THE LEFT OR ON THE RIGHT SIDE OF THE HANDLEBAR. DEDICATED FIXING KIT IS SOLD SEPARATELY (USE THE MOUNTING KIT OF LEVER PROTECTIONS).

LO SPECCHIETTO CIRCULAR È STATO SVILUPPATO CON SISTEMA DI FISSAGGIO ACCANTO ALLE MANOPOLE AL POSTO DEL TERMINALE MANUBRIO. BRACCIO DI FISSAGGIO E CORPO REALIZZATI IN ALLUMINIO LAVORATO CNC. VETRO SPECCHIO AZZURRATO E CONVESSO COME DA NORMATIVA. LE MISURE SONO LE SEGUENTI: DIAMETRO 101 MM E 29 MM DI PROFONDITÀ. LO SPECCHIO PERMETTE IL MONTAGGIO INDIFFERENTEMENTE SULLA SINISTRA O SULLA DESTRA DEL MANUBRIO. GLI ATTACCHI SPECIFICI SONO VENDUTI SEPARATAMENTE (UTILIZZARE ATTACCHI DELLE PROTEZIONI LEVE).

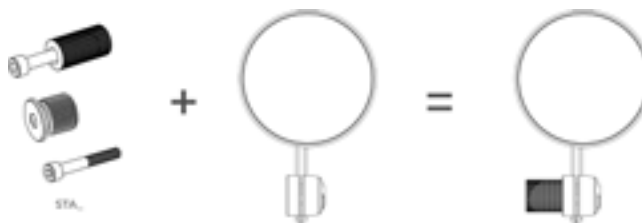

00
BLACK - NERO

USE ONLY DOT4 BRAKE FLUID
FROM A SEALED CONTAINER
CLEAN FILLER CAP BEFORE
REMOVING



HANDLEBAR MIRROR HOLE COVER

TAPPI FORI SPECCHI MANUBRIO



HANDLEBAR MIRROR HOLE CAP MADE WITH ALU ALLOY CNC MACHINED. THIS CAP WAS DEVELOPED TO COVER THE HOLE OF THE STANDARD MIRROR MOUNTED ON THE HANDLEBARS. IT IS AVAILABLE WITH OXIDATION IN DIFFERENT COLORS AND IS BRANDED VALTER MOTO COMPONENTS. THE PACKAGE CONTAINS A SINGLE CAP.

TAPPO FORO SPECCHIO MANUBRIO RICAVATO DAL PIENO IN LEGA DI ALLUMINIO LAVORATO CNC. QUESTO TAPPO È STATO SVILUPPATO PER COPRIRE IL FORO DELLO SPECCHIO STANDARD MONTATO SUI MANUBRI. È DISPONIBILE CON OSSIDAZIONE ANODICA IN DIVERSI COLORI ED È PERSONALIZZATO VALTER MOTO COMPONENTS. NELLA CONFEZIONE È PRESENTE UN TAPPO SINGOLO.

TAPPO FORO SPECCHIO MANUBRIO PASSO 1.25 DX

ACV076A

TAPPO FORO SPECCHIO MANUBRIO PASSO 1.50 DX

ACV076B

TAPPO FORO SPECCHIO MANUBRIO PASSO 1.25 SX

ACV076C

00 BLACK - NERO
04 RED - ROSSO
05 TITANIUM

OPTIONAL

	Code - Codice
Fixing pin Ø10*1,5 Perno di fissaggio Ø10*1,5	SPXA02A

THE PIN IS USED ONLY FOR MIRRORS SPX10 AND SPX12

IL PERNO È UTILIZZABILE SOLO CON GLI SPECCHIETTI SPX10 E SPX12

	Code - Codice
Fixing pin Ø10*1,5 Perno di fissaggio Ø10*1,5	SPXA02
Fixing pin Ø10*1,25 left Perno di fissaggio Ø10*1,25 sx	SPXA01A

THE PIN IS USED ONLY FOR MIRRORS SPX01L/SPX01R E SPX08

IL PERNO È UTILIZZABILE SOLO CON GLI SPECCHIETTI SPX01L/SPX01R E SPX08

	Code - Codice
handlebars adapter Ø 11	TMA28
handlebars adapter Ø 13	TMA11
handlebars adapter Ø 16	TMA10
handlebars adapter Ø 18	TMA29

HANDLEBARS ADAPTERS IS USED ONLY FOR MIRRORS SPX11, SPX13 E SPX09

KIT ATTACCO TERMINALI MANUBRIO È UTILIZZABILE SOLO CON GLI SPECCHIETTI SPX11, SPX13 E SPX09

GRIPS AND HANDLEBAR



GRIPS

MANOPOLE



TOP GRIPS
MANOPOLE TOP

GRPO1

TOP GRIPS ARE PERFECT TO IMPROVE BIKE LOOK AND TO OFFER A SAFER HOLD. THESE GRIPS ARE MADE WITH "NO-SLIPPERY" RUBBER ENRICHED BY THREE ALU INSERT CNC MACHINED AVAILABLE IN DIFFERENT COLORS. EXTERNAL Ø 32 MM AND FIT ON ALL Ø 22 HANDLEBAR. THREE THROTTLE GEAR ARE INCLUDED FOR MOST POPULAR BIKES USE. UNUSABLE ON APRILIA, MV, KTM, BMW AND ELECTRONIC THROTTLE SYSTEM.

LE MANOPOLE TOP GRIP SONO PERFETTE PER MIGLIORARE L'ESTETICA E GARANTIRE UNA PRESA SICURA. QUESTO MODELLO DI MANOPOLE È REALIZZATO CON UNA GOMMA ANTISCIVOLO ED È ARRICCHITA DA 3 INSERTI IN ALLUMINIO LAVORATI CON MACCHINE A CONTROLLO NUMERICO. IL Ø ESTERNO È 32 MM E POSSONO ESSERE MONTATE SU TUTTI I MANUBRI Ø 22. IL TUBO PER IL COMANDO DEL GAS È PREASSEMBLATO E TRAMITE LE 3 GHIERE INCLUSE CONSENTE L'UTILIZZO DELLE MANOPOLE SUI MODELLI DI MOTO PIÙ COMUNI. IL COMANDO GAS NON È COMPATIBILE CON APRILIA, MV, KTM, BMW ED I COMANDI ELETTRONICI.

00	02	03	04	05	07	16
BLACK - NERO	BLUE - BLU	GOLD - ORO	RED - ROSSO	TITANIUM	GREEN - VERDE	ORANGE - ARANCIONE



STREET GRIPS
MANOPOLE STREET

GRPO2

STREET GRIPS ARE PERFECT TO GIVE A REMARKABLE LOOK TO THE BIKE AND TO OFFER A SAFER HOLD. THESE GRIPS ARE MADE WITH "NO-SLIPPERY" RUBBER ENRICHED BY THREE ALU RINGS AVAILABLE IN DIFFERENT COLORS. EXTERNAL Ø 32 MM AND FIT ON ALL Ø 22 HANDLEBAR. THREE THROTTLE GEAR ARE INCLUDED FOR MOST POPULAR BIKES USE. UNUSABLE ON APRILIA, MV, KTM, BMW AND ELECTRONIC THROTTLE SYSTEM.

LE MANOPOLE STREET SONO OTTIME PER DARE UN NUOVO LOOK ALLA MOTO E GARANTIRE UNA PRESA SICURA. QUESTO MODELLO DI MANOPOLE È REALIZZATO CON UNA GOMMA ANTISCIVOLO ED È ARRICCHITA DA 3 ANELLI IN ALLUMINIO LAVORATI CON MACCHINE A CONTROLLO NUMERICO. IL Ø ESTERNO È 32 MM E POSSONO ESSERE MONTATE SU TUTTI I MANUBRI Ø 22. IL TUBO PER IL COMANDO DEL GAS È PREASSEMBLATO E TRAMITE LE 3 GHIERE INCLUSE CONSENTE L'UTILIZZO DELLE MANOPOLE SUI MODELLI DI MOTO PIÙ COMUNI. IL COMANDO GAS NON È COMPATIBILE CON APRILIA, MV, KTM, BMW ED I COMANDI ELETTRONICI.



HANDLEBARS

MANUBRI



148

NAKED HANDLEBAR HIGH BEND Ø22 - 65H
MANUBRIO NAKED PIEGA ALTA Ø22 - 65H

MN01

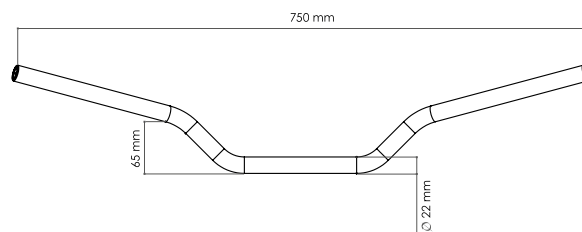

00	02	03	04	07
BLACK - NERO	BLUE - BLU	GOLD - ORO	RED - ROSSO	GREEN - VERDE



NAKED HANDLEBAR LOW BEND Ø22 - 45H
MANUBRIO NAKED PIEGA BASSA Ø22 - 45H

MN02

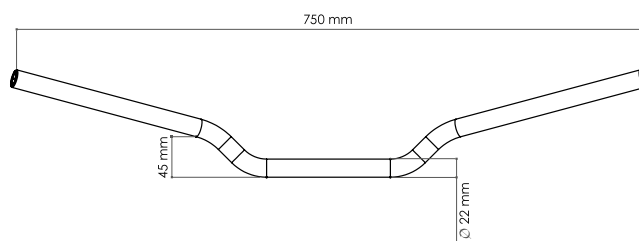

00	02	03	04	07
BLACK - NERO	BLUE - BLU	GOLD - ORO	RED - ROSSO	GREEN - VERDE

PASSENGER HANDLES AND SADDLEBAGS SUPPORTS



PASSENGER HANDLES

MANIGLIE PASSEGGERO



VMC PASSENGER HANDLES ARE MADE IN STRONG STEEL HIGH THICKNESS COATED WITH RUBBER GRIP. DESIGNED TO PERFECTLY FIT ON SPECIFIC BIKES THEY DOESN'T REQUIRE ANY MODIFY FOR MOUNTING. AVAILABLE IN BLACK COLOR ONLY.

LE MANIGLIE PASSEGGERO VMC SONO REALIZZATE IN ACCIAIO RESISTENTE AD ALTO SPESSORE RIVESTITO IN MORBIDA GOMMA ANTISCIVOLO. SONO PROGETTATE PER IL MONTAGGIO SULLA MOTO SENZA CHE SIA RICHIESTA ALCUNA MODIFICA.

00
BLACK - NERO

Model - Modello	Year - Anno	Code - Codice
KAWASAKI		
Z750	07-13	ALK02
Z650	17-22	HND08
Z1000	07-09	ALK02
KTM		
SUPERDUKE 1290	17-18	HND09
MV AGUSTA		
TURISMO VELOCE	14-22	HND10
B3 (E4-E5)	18-22	HND11*
SUZUKI		
SV650	16-22	HND05
GSX -S1000	15-19	HND06
YAMAHA		
MT07	14-17	HND03
MT09	13-16	HND04
MT10	16-21	HND07

* FULL ALUMINIUM MACHINING WITH CNC MACHINES

* LAVORAZIONE DAL PIENO DI ALLUMINIO CON MACCHINE CNC

SADDLEBAGS SUPPORTS

SUPPORTI BORSE



VMC SIDE BAGS SUPPORTS ARE MADE IN STRONG HIGH THICKNESS STEEL. THESE SUPPORTS MOUNTED ON THE BIKE AVOID THAT REAR SADDLE BAGS AND SOFT BAGS CAN TOUCH THE REAR WHEEL CAUSING DAMAGE AND BECOMING UNSAFE. DESIGNED TO PERFECTLY FIT ON SPECIFIC BIKES THEY DON'T REQUIRE ANY MODIFY FOR MOUNTING. AVAILABLE IN BLACK COLOR ONLY.

I SUPPORTI BORSE LATERALI VMC SONO REALIZZATI IN ACCIAIO RESISTENTE DI ALTO SPESSORE. QUESTI SUPPORTI BORSE LATERALI SONO STATI SVILUPPATI PER EVITARE CHE LE BORSE MORBIDE POSSANO ENTRARE IN CONTATTO CON LA RUOTA POSTERIORE DANNEGGIANDOSI E CREANDO UNA SITUAZIONE DI PERICOLO. IL PRODOTTO È SVILUPPATO PER OGNI SINGOLO MODELLO DI MOTO PERMETTENDO UN MONTAGGIO FACILE CHE NON RICHIEDE ALCUNA MODIFICA. DISPONIBILI SOLO NEL COLORE NERO.

00
BLACK - NERO

Model - Modello	Year - Anno	Code - Codice	Code - Codice
			Central plate - Piastra centrale
YAMAHA			
MT07	14-17	ALY05	
MT09	13-16	ALY06	
KAWASAKI			
Z650	17-22	ALK03	
MV AGUSTA			
B3 (EURO4-EURO5)	18-22	ALV04*	ALV05*

* IT IS ASSEMBLED BY PURCHASING THE HANDLES

* SI MONTA ACQUISTANDO LE MANIGLIE PASSEGGERO

INDICATORS



TURN LIGHT INDICATORS

FRECCE



SHARP LED INDICATORS (PAIR)
FRECCE LED SHARP (COPPIA)

IND001 

UNIVERSAL 12V LED INDICATORS ARROW SHAPED SHORT STEM . ALUMINUM BLACK BODY WITH AMBER HI-BRIGHTNESS LED, CLEAR LENS. TWO RESISTORS INCLUDED E-MARKED TWO PCS PACKAGE.

FRECCE UNIVERSALI A LED 12V CON GAMBO CORTO E FORMA A PUNTA DI FRECCIA. CORPO IN ALLUMINIO CON LENTE TRASPARENTE E LED AD ALTA LUMINOSITÀ ARANCIONI. LA CONFEZIONE COMPRENDE DUE FRECCHE "E" MARKED E DUE RESISTENZE.



SPEAR LED INDICATORS (PAIR)
FRECCE LED SPEAR (COPPIA)

IND002 

UNIVERSAL 12V LED INDICATORS ARROW SHAPED SHORT STEM . ALUMINUM BLACK BODY WITH AMBER HI-BRIGHTNESS LED, CLEAR LENS. TWO RESISTORS INCLUDED E-MARKED TWO PCS PACKAGE.

FRECCE UNIVERSALI A LED 12V CON GAMBO CORTO. CORPO IN ALLUMINIO CON LENTE TRASPARENTE E LED AD ALTA LUMINOSITÀ ARANCIONI. LA CONFEZIONE COMPRENDE DUE FRECCHE "E" MARKED E DUE RESISTENZE.



SLIDE LED INDICATORS (PAIR)
FRECCHE LED SLIDE (COPPIA)

IND007



PRODUCT DEVELOPED FOLLOWING THE THE NEW TREND OF LED ARROWS WITH LATERAL SLIDING LIGHTING. BODY IN ABS WITH DARK LENS AND ANTI-VIBRATION RUBBER. THE HOMOLOGATION CODE IS EMBOSSED ON THE LENS. THE ARTICLE CONSISTS OF A PAIR OF INDICATORS.

PRODOTTO DERIVATO DALLA NUOVA TENDENZA DI FRECCHE LED CON ILLUMINAZIONE A SCORRIMENTO LATERALE. CORPO IN ABS CON LENTE SCURA E GOMMINI ANTIVIBRAZIONE. SULLA LENTE È PRESENTE IL CODICE DI OMOLOGAZIONE. L'ARTICOLO È COMPOSTO DA UNA COPPIA DI FRECCHE.



FIX LED INDICATORS (PAIR)
FRECCHE LED FISSA (COPPIA)

IND007F



PRODUCT DEVELOPED FOLLOWING THE THE NEW TREND OF LED TURN LIGHT INDICATORS WITH FIX LIGHTING. BODY IN ABS WITH DARK LENS AND ANTI-VIBRATION RUBBER. THE HOMOLOGATION CODE IS EMBOSSED ON THE LENS. THE ARTICLE CONSISTS OF A PAIR OF INDICATORS.

PRODOTTO DERIVATO DALLA NUOVA TENDENZA DI FRECCHE LED CON ILLUMINAZIONE FISSA. CORPO IN ABS CON LENTE SCURA E GOMMINI ANTIVIBRAZIONE. SULLA LENTE È PRESENTE IL CODICE DI OMOLOGAZIONE. L'ARTICOLO È COMPOSTO DA UNA COPPIA DI FRECCHE.



SLIDE LED INDICATORS WITH POSITION WHITE LAMP (PAIR)
FRECCHE LED SLIDE CON LUCE BIANCA DI POSIZIONE (COPPIA)

IND008B



LED TURN LIGHT INDICATORS WITH LATERAL SLIDING LIGHTING AND POSITION (SIDE) LAMP WHITE. BODY IN ABS WITH DARK LENS AND ANTI-VIBRATION RUBBER. THE HOMOLOGATION CODE IS EMBOSSED ON THE LENS. THE ARTICLE CONSISTS OF A PAIR OF INDICATORS.

FRECCHE LED CON ILLUMINAZIONE A SCORRIMENTO LATERALE E LUCE DI POSIZIONE BIANCA. CORPO IN ABS CON LENTE SCURA E GOMMINI ANTIVIBRAZIONE. SULLA LENTE È PRESENTE IL CODICE DI OMOLOGAZIONE. L'ARTICOLO È COMPOSTO DA UNA COPPIA DI FRECCHE.



SLIDE LED INDICATORS WITH POSITION RED LAMP (PAIR)
FRECCHE LED SLIDE CON LUCE ROSSA DI POSIZIONE (COPPIA)

IND008R



LED TURN LIGHT INDICATORS WITH LATERAL SLIDING LIGHTING AND POSITION (SIDE) LAMP RED. BODY IN ABS WITH DARK LENS AND ANTI-VIBRATION RUBBER. THE HOMOLOGATION CODE IS EMBOSSED ON THE LENS. THE ARTICLE CONSISTS OF A PAIR OF INDICATORS.

FRECCHE LED CON ILLUMINAZIONE A SCORRIMENTO LATERALE E LUCE DI POSIZIONE ROSSA. CORPO IN ABS CON LENTE SCURA E GOMMINI ANTIVIBRAZIONE. SULLA LENTE È PRESENTE IL CODICE DI OMOLOGAZIONE. L'ARTICOLO È COMPOSTO DA UNA COPPIA DI FRECCHE.

	Code - Codice
Universal Wiring Light (2 wire) Cablaggio Universale (2 fili)	INC
Bmw Wiring Light (2 wire) Cablaggio Bmw (2 fili)	INCBMW
Kawasaki Wiring Light (2 wire) Cablaggio Kawasaki (2 fili)	INCKAW
Triumph Wiring Light (2 wire) Cablaggio Triumph (2 fili)	INCTRI
Suzuki Wiring Light (2 wire) Cablaggio Suzuki (2 fili)	INCSUZ
Ktm Wiring Light (2 wire) Cablaggio Ktm (2 fili)	INCKTM
Honda Wiring Light (2 wire) Cablaggio Honda (2 fili)	INCHON
Yamaha Wiring Light MT07/MT09 (2 wire) Cablaggio Yamaha MT07/MT09 (2 fili)	INCYAM
Yamaha Wiring Light (2 wire) Cablaggio Yamaha (2 fili)	INCYAM2



	Code - Codice
Yamaha Wiring Light (3 wire) Cablaggio Yamaha (3 fili)	INCYAM3
Honda Wiring Light (3 wire) Cablaggio Honda (3 fili)	INCHON3



OPTIONAL



LED INDICATORS RELAY
RELÈ FRECCE LED

INDRO1

Model - Modello	Year - Anno	Code - Codice
BMW		
S 1000 R / RR	09-18	PSFB01
F 800 R	09-14	PSFB01
DUCATI		
PANIGALE 899 / 1199 / S	12-15	PSFH01
MULTISTRADA 1200 / S	10-17	PSFH01
STREET FIGHTER 848	11-15	PSFY01
STREET FIGHTER / S	09-13	PSFY01
SCRAMBLER	15-18	PSFD01
HONDA		
CBR 600 RR ABS	09-16	PSFH01
CBR 600 RR	03-12	PSFH01
	13-16	PSFH02
CBR 600 F	95-13	PSFH01
CBR 1000 RR / ABS	04-16	PSFH01
VTR 1000 SP1 / 2	00-06	PSFH01
HORNET 600	98-13	PSFH01
HORNET 900	02-06	PSFH01
CB 1000 R	08-17	PSFH01
KAWASAKI		
NINJA 250	07-13	PSFK01
NINJA 300	12-17	PSFK01
ZX 6-636 R / RR	95-04	PSFK01
	05-06	PSFK02**
	07-08	PSFK01
	09-17	PSFS01
ZX 9 R	98-05	PSFK01
ZX 10 R	04-15	PSFK01
	16-18	PSFK04
Z 1000 SX	07-18	PSFK01
ZZR 1400	06-18	PSFK01
VERSYS 650 ABS	12-18	PSFK03
ER6N	05-11	PSFH01
	12-16	PSFK03
Z 650	17-18	PSFK03
Z 750	03-06	PSFK01
Z 750 R	07-13	PSFK01
Z 800	13-16	PSFK03

Model - Modello	Year - Anno	Code - Codice
Z 900	17-18	PSFK03
Z 1000	03-13	PSFK01
	14-18	PSFK03
MV AGUSTA		
B3	16-22	PSFM01
BRUTALE 1000	19-22	PSFM01
SUZUKI		
RGV 250 GAMMA	91-96	PSFS01
GSX 600 R / GSX 750 R	00-17	PSFS01
GSX 1000R / ABS	01-16	PSFS01
GSXR 1000	17-18	PSFY01
GSX 1300 R HAYABUSA	08-17	PSFS01
V STROM 1000	16-19	PSFS01
GSX -S125	17-22	PSFS01
SV 650	99-18	PSFS01
GLADIUS 650	09-15	PSFS01
GSR 600 / GSR 750	06-16	PSFS01
GSX -S750	17-18	PSFS01
GSX -S1000	15-18	PSFS01
SV 1000	03-06	PSFS01
B-KING	07-12	PSFS01
YAMAHA		
R125	08-18	PSFY02
R6	03-18	PSFY01
R1	02-14	PSFY01
	15-18	PSFY03*
XJ6	09-15	PSFY01
FZ6	04-07	PSFY01
FZ8	10-16	PSFY01
FZ1	06-15	PSFY01
MT07	14-18	PSFY01
MT09	13-16	PSFY01
MT10	16-18	PSFY01
TRIUMPH		
DAYTONA 675	06-16	PSFT01
STREET TRIPLE	13-16	PSFT01
SPEED TRIPLE	11-15	PSFT01

**PIASTRINE PER MONTAGGIO FRECCHE SOTTOCODONE | *PIASTRINE PER MONTAGGIO FRECCHE ANTERIORI A CARENA

FORK PRELOAD ADJUSTER



FORK PRELOAD ADJUSTER

GHIERE PRECARICO FORCELLA



ENTIRELY MADE WITH CNC MACHINERY IN ALUMINUM ALLOY THEY FIT PERFECTLY ON OEM FORK CAP. ARE PROVIDED WITH ALLEN KEY FOR AN EASY FIX.

REALIZZATE IN ALLUMINIO E LAVORATE CON MACCHINE CNC A CONTROLLO NUMERICO, SI MONTANO PERFETTAMENTE SULLA TESTA DELLA FORCELLA CHE PREVEDE LA REGOLAZIONE DEL PRECARICO. LA CHIAVE A BRUGOLA PER IL BLOCCAGGIO DELLA GHIERA È INCLUSA.

00	02	03	04	07
BLACK - NERO	BLUE - BLU	GOLD - ORO	RED - ROSSO	GREEN - VERDE
				ONLY KAWASAKI



Model - Modello	Year - Anno	Code - Codice
APRILIA		
RSV 1000	98-03	GRFX04
	04-05	GRFX02
RSV4/R/APRC	09-18	GRFX02
TUONO 1000	03-10	GRFX04
TUONO V4	11-14	GRFX02
BMW		
S 1000 RR	09-14	GRFX02
	15-18	GRFX06
DUCATI		
748	93-03	GRFX04
916	93-00	GRFX04
998	02-03	GRFX04
749/999	03-06	GRFX04
848	08-13	GRFX04
1098	07-09	GRFX04
1198	09-11	GRFX04
MONSTER S4R	01-08	GRFX04
HONDA		
CBR 600 F	95-06	GRFX05
	11-13	GRFX03
CBR 600 R / RR	03-04	GRFX05
	05-06	GRFX04
	07-17	GRFX03
CBR 900	94-99	GRFX05
	00-03	GRFX04
CBR 1000 RR	04-07	GRFX04
	08-16	GRFX03
HORNET 600	07-13	GRFX03
CB 1000 R	08-17	GRFX03
KAWASAKI		
ZX 6-636 R / RR	98-02	GRFX02
	03-04	GRFX01

Model - Modello	Year - Anno	Code - Codice
	05-06	GRFX04
	07-08	GRFX03
ZX 9 R	98-05	GRFX02
ZX 10 R	04-10	GRFX01
Z 1000 SX	07-17	GRFX03
ZZR 1400	06-18	GRFX01
Z 750	07-13	GRFX01
Z 750R	11-13	GRFX03
Z 1000	03-06	GRFX04
SUZUKI		
GSX 600 / 750 R	97-05	GRFX04
	06-16	GRFX03
GSX 1000 R	01-08	GRFX01
V STROM 1000	16-19	GRFX01
GSR 750	10-16	GRFX01
GSX -S750	17-20	GRFX01
GSX -S1000 -950	15-22	GRFX01
B-KING	07-12	GRFX01
YAMAHA		
R6	99-04	GRFX02
	2005	GRFX01
	06-07	GRFX02
	08-16	GRFX01
R1	98-14	GRFX01
TDM 900	02-14	GRFX02
FAZER 1000	00-05	GRFX02
MT09	13-16	GRFX01
FZ1	06-15	GRFX01
TRIUMPH		
DAYTONA 675 / R	06-16	GRFX01
STREET TRIPLE / R	13-16	GRFX01
SPEED TRIPLE / R	05-10	GRFX04
	11-15	GRFX03

FRONT LIGHT GRID



FRONT LIGHT GRID

COVER FARO



168

FRONT LIGHT PROTECTION MADE FOR NAKED, CLASSIC AND CAFE RACE BIKE. MADE WITH 2 MM. STEEL IS BLACK EPOXY PAINTED TO LAST IN TIME. THIS PRODUCT IS UNIVERSAL AND CAN BE MOUNTED ON ALL FRONT LIGHT ROUND SHAPE WITH HUB SPACING OF 200 MM. THE GRID PROVIDES A GOOD PROTECTION AND OFFER AN ENDEARING NEW LOOK TO THE BIKE.

GRIGLIA FARO UNIVERSALE SVILUPPATA PER L'UTILIZZO SU MOTO NAKED, CLASSIC E CAFÈ RACE. REALIZZATA IN ACCIAIO SPESSORE 2 MM. DISPONIBILE NEL COLORE NERO CON VERNICIATURA EPOSSIDICA PER DURARE NEL TEMPO. I FORI DI FISSAGGIO RENDONO QUESTA GRIGLIA UNIVERSALE PER IL MONTAGGIO SU FARI ANTERIORI Ø200 MM. LA GRIGLIA OFFRE UNA BUONA PROTEZIONE ED UN NUOVO LOOK ALLA MOTO.

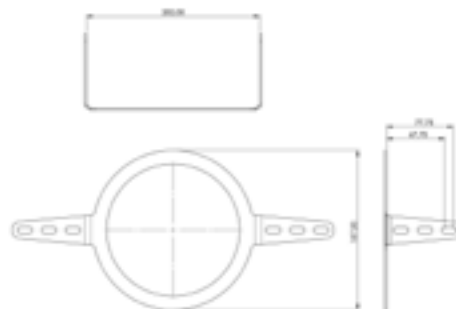

00
BLACK - NERO



FRONT LIGHT GRID "STYLE A"
GRIGLIA FARO ANTERIORE "MODELLO A"

ACV051A



FRONT LIGHT GRID "STYLE B"
GRIGLIA FARO ANTERIORE "MODELLO B"

ACV051B



FRONT LIGHT GRID "STYLE C"
GRIGLIA FARO ANTERIORE "MODELLO C"

ACV051C

ACCESSORIES





	Code - Codice	Color - Colore
Ring Ray two wheel stickers kit Strisce cerchi	RR01 02	Blue - Blu
Ring Ray two wheel stickers kit Strisce cerchi	RR01 07	Green - Verde
Ring Ray two wheel stickers kit Strisce cerchi	RR02 12	Yellow - Giallo
Ring Ray two wheel stickers kit Strisce cerchi	RR02 16	Orange - Arancione
Ring Ray two wheel stickers kit Strisce cerchi	RR03 01	Reflective - Rinfrangente



RING RAY TWO WHEEL STICKERS KIT
STRISCE CERCHI

RR04

02 BLUE - BLU 04 RED - ROSSO 07 GREEN - VERDE 12 YELLOW - GIALLO



TYRE CAPS
TAPPI VALVOLE RUOTE

TVL01

00 BLACK - NERO 02 BLUE - BLU 03 GOLD - ORO 04 RED - ROSSO 05 TITANIUM 07 GREEN - VERDE 16 ORANGE - ARANCIONE



TANK PROTECTION STICKY CLASSIC LARGE
PARASERBATOIO CLASSIC GRANDE

AV01



TANK PROTECTION STICKY SPECIAL
PARASERBATOIO SPECIAL

AV01S



CONICAL SPACER HOLE 6
DISTANZIALE CONICO FORO 6

ACV018 6

CONICAL SPACER HOLE 8
DISTANZIALE CONICO FORO 8

ACV018 8

- | | | | | | | |
|--------------|------------|------------|-------------|----------|---------------|--------------------|
| 00 | 02 | 03 | 04 | 05 | 07 | 16 |
| BLACK - NERO | BLUE - BLU | GOLD - ORO | RED - ROSSO | TITANIUM | GREEN - VERDE | ORANGE - ARANCIONE |



HEAT EXHAUST PIPER WRAP 5 Mt 50 H
TELA TERMICA 5 Mt 50 H

ACV044

HIGH THERMAL RESISTANCE HEAT PIPE EXHAUST WRAP THAT CAN RESIST UP TO 1000°. ROLL LENGT 5 Mt. HEIGHT 5 CM. TO IMPROVE PERFORMANCE IT IS THREATED WITH GRAPHITE. TWO FIXING CLAMPS ARE INCLUDED. THIS PRODUCT IS MAINLY USED IN MOTOR RACING TO MANTEIN HIGH TEMPERATURE AND IMPROVE GAS EXIT.

GARZA TERMICA PER COLLETTORI IN GRADO DI RESISTERE AD UNA TEMPERATURA FINO A 1000°. LA LUNGHEZZA DEL ROTOLO È 5 Mt. E L'ALTEZZA 5 CM. LA TELA È STATA SOTTOPOSTA AD UN TRATTAMENTO CON GRAFITE PER MIGLIORARNE LA PERFORMANCE. NELLA CONFEZIONE SONO INCLUSE 2 FASCETTE DI FISSAGGIO IN ACCIAIO. QUESTO PRODOTTO VIENE GENERALMENTE UTILIZZATO NELLE COMPETIZIONI PER MANTENERE ELEVATA LA TEMPERATURA DEL COLLETTORE E MIGLIORARE L'USCITA DEI GAS.

LED SPOTLIGHTS
FARETTO SUPPLEMENTARE LED

AR56

LED SPOTLIGHT TO IMPROVE SAFE IN NIGHT VISION. ALUMINUM BODY COVERED WITH AN HIGH STRENGHT BLACK PAINT. DURABLE LAMP 12-48V - 15W ICE LIGHT 6000K. DOUBLE INTERNAL AND EXTERNAL COOLING SYSTEM. STEEL CLIP-ON BRACELET FOR Ø20-30 INCLUDED. IT IS POSSIBLE TO ADJUST XY ORIENTATION. 3 ALLEN KEYS FOR MOUNTING INCLUDED.

IL FARETTO SUPPLEMENTARE A LED SERVE A MIGLIORARE SENSIBILMENTE L'ILLUMINAZIONE PER LA VISIBILITÀ NOTTURNA. IL CORPO È REALIZZATO IN ALLUMINIO CON VERNICIATURA NERA AD ALTA RESISTENZA. LAMPADA A LUNGA DURATA 12-48V 15W GHIACCIO 6000K. DOPPIO SISTEMA DI RAFFREDDAMENTO INTERNO/ESTERNO. È INCLUSO UN BRACCIALE IN ACCIAIO PER IL MONTAGGIO SU SUPPORTI Ø20-30 CHE CONSENTE LA REGOLAZIONE SUGLI ASSI X/Y. LE TRE CHIAVI A BRUGOLA PER IL MONTAGGIO SONO COMPRESSE NELLA CONFEZIONE.



CLOTHING

ABBIGLIAMENTO



T-SHIRT WHITE VMC
MAGLIETTA BIANCA VMC

XS/S/M/L

ABB001



T-SHIRT COLOR VMC
MAGLIETTA COLORATA VMC

XS/S/M/L/XL

ABB002



T-SHIRT BLACK VMC
MAGLIETTA NERA VMC

S/M/L/XL

ABB004



SWEATSHIRT BLACK VMC
FELPA NERA VMC

S/M/L/XL

ABB005

BOLTS



DOME HEAD SCREW

VITE TESTA BOMBATA

Codice - Code	Misura - Measures
VMC037 10 S	Ø 14 x m6 x 10
VMC037 15 S	Ø 14 x m6 x 15
VMC037 20 S	Ø 14 x m6 x 20
VMC037 25 S	Ø 14 x m6 x 25
VMC037 30 S	Ø 14 x m6 x 30
VMC037 35 S	Ø 14 x m6 x 35
VMC037 40 S	Ø 14 x m6 x 40
VMC037 45 S	Ø 14 x m6 x 45
VMC037 50 S	Ø 14 x m6 x 50
VMC038 10 S	Ø 14 r.3,6 x m6 x 10
VMC038 15 S	Ø 14 r.3,6 x m6 x 15
VMC038 20 S	Ø 14 r.3,6 x m6 x 20
VMC038 25 S	Ø 14 r.3,6 x m6 x 25
VMC038 30 S	Ø 14 r.3,6 x m6 x 30
VMC038 35 S	Ø 14 r.3,6 x m6 x 35
VMC039 10 S	Ø 14 r.4,8 x m6 x 10
VMC039 15 S	Ø 14 r.4,8 x m6 x 15
VMC039 20 S	Ø 14 r.4,8 x m6 x 20
VMC040 10 S	Ø 14 r.6 x m6 x 10
VMC040 15 S	Ø 14 r.6 x m6 x 15
VMC040 20 S	Ø 14 r.6 x m6 x 20
VMC041 10 S	Ø 14 r.3,5 x m5 x 10
VMC041 15 S	Ø 14 r.3,5 x m5 x 15
VMC041 20 S	Ø 14 r.3,5 x m5 x 20
VMC042 10 S	Ø 14 x m5 x 10
VMC042 15 S	Ø 14 x m5 x 15

Codice - Code	Misura - Measures
VMC042 20 S	Ø 14 x m5 x 20
VMC042 25 S	Ø 14 x m5 x 25
VMC042 30 S	Ø 14 x m5 x 30
VMC043 10 S	Ø 16 x m6 x 10
VMC043 15 S	Ø 16 x m6 x 15
VMC043 20 S	Ø 16 x m6 x 20
VMC043 25 S	Ø 16 x m6 x 25
VMC043 30 S	Ø 16 x m6 x 30
VMC043 35 S	Ø 16 x m6 x 35
VMC043 40 S	Ø 16 x m6 x 40
VMC044 10 S	Ø 18 r.9,8 x m6 x 10
VMC044 15 S	Ø 18 r.9,8 x m6 x 15
VMC044 20 S	Ø 18 r.9,8 x m6 x 20
VMC045 10 S	Ø 18 r.8,2 x m6 x 10
VMC045 15 S	Ø 18 r.8,2 x m6 x 15
VMC045 20 S	Ø 18 r.8,2 x m6 x 20
VMC046 10 S	Ø 17 r.6 x m6 x 10
VMC046 15 S	Ø 17 r.6 x m6 x 15
VMC046 20 S	Ø 17 r.6 x m6 x 20
VMC047 10 S	Ø 12 x m5 x 10
VMC047 15 S	Ø 12 x m5 x 15
VMC047 20 S	Ø 12 x m5 x 20
VMC047 25 S	Ø 12 x m5 x 25
VMC047 30 S	Ø 12 x m5 x 30
VMC048 10 S	Ø 10 x m6 x 10
VMC048 15 S	Ø 10 x m6 x 15

Codice - Code	Misura - Measures
VMC048 20 S	Ø 10 x m6 x 20
VMC048 25 S	Ø 10 x m6 x 25
VMC048 30 S	Ø 10 x m6 x 30
VMC048 35 S	Ø 10 x m6 x 35
VMC048 40 S	Ø 10 x m6 x 40
VMC050 10 S	Ø 8 x m4 x 10
VMC050 15 S	Ø 8 x m4 x 15
VMC050 20 S	Ø 8 x m4 x 20
VMC050 25 S	Ø 8 x m4 x 25
VMC050 30 S	Ø 8 x m4 x 30
VMC056 10 S	Ø 22 r.5 x m6 x 10
VMC056 15 S	Ø 22 r.5 x m6 x 15
VMC056 20 S	Ø 22 r.5 x m6 x 20

Codice - Code	Misura - Measures
VMC056 25 S	Ø 22 r.5 x m6 x 25
VMC056 30 S	Ø 22 r.5 x m6 x 30
VMC057 10 S	Ø 14 r.23 x m6 x 10
VMC057 15 S	Ø 14 r.23 x m6 x 15
VMC058 15 S	Ø 12 x 15 autofilet.
VMC146 12 S	Ø 7,8 x m4 x 12
VMC147 10 S	Ø 9,8 x m5 x 10
VMC147 15 S	Ø 9,8 x m5 x 15
VMC147 20 S	Ø 9,8 x m5 x 20
VMC147 25 S	Ø 9,8 x m5 x 25
VMC147 30 S	Ø 9,8 x m5 x 30
VMC408 10 S	Ø 14 r.2,5 x m5 x 10
VMC644 13 S	Ø 18 r.2,9 x m6 x 13

00 BLACK - NERO 01 SILVER 02 BLUE - BLU 03 GOLD - ORO 04 RED - ROSSO 07 GREEN - VERDE



CAP HEAD SCREW

VITE TESTA CILINDRICA

Codice - Code	Misura - Measures
VMC049 10 S	Ø 10 x m4 x 10
VMC049 20 S	Ø 10 x m4 x 20
VMC051 08 S	Ø 8,5 x m5 x 08
VMC051 10 S	Ø 8,5 x m5 x 10
VMC051 15 S	Ø 8,5 x m5 x 15
VMC051 20 S	Ø 8,5 x m5 x 20
VMC051 25 S	Ø 8,5 x m5 x 25
VMC051 30 S	Ø 8,5 x m5 x 30
VMC051 35 S	Ø 8,5 x m5 x 35
VMC051 40 S	Ø 8,5 x m5 x 40
VMC051 45 S	Ø 8,5 x m5 x 45
VMC051 50 S	Ø 8,5 x m5 x 50
VMC052 10 S	Ø 7 x m4 x 10
VMC052 15 S	Ø 7 x m4 x 15
VMC052 20 S	Ø 7 x m4 x 20
VMC052 25 S	Ø 7 x m4 x 25
VMC052 30 S	Ø 7 x m4 x 30
VMC052 35 S	Ø 7 x m4 x 35
VMC052 40 S	Ø 7 x m4 x 40
VMC054 15 S	Ø 13 x m8 x 15
VMC054 20 S	Ø 13 x m8 x 20
VMC054 25 S	Ø 13 x m8 x 25
VMC054 30 S	Ø 13 x m8 x 30
VMC054 35 S	Ø 13 x m8 x 35
VMC054 40 S	Ø 13 x m8 x 40
VMC054 45 S	Ø 13 x m8 x 45

Codice - Code	Misura - Measures
VMC054 50 S	Ø 13 x m8 x 50
VMC054 55 S	Ø 13 x m8 x 55
VMC054 60 S	Ø 13 x m8 x 60
VMC055 10 S	Ø 10 x m6 x 10
VMC055 15 S	Ø 10 x m6 x 15
VMC055 20 S	Ø 10 x m6 x 20
VMC055 25 S	Ø 10 x m6 x 25
VMC055 30 S	Ø 10 x m6 x 30
VMC055 35 S	Ø 10 x m6 x 35
VMC055 40 S	Ø 10 x m6 x 40
VMC055 45 S	Ø 10 x m6 x 45
VMC055 50 S	Ø 10 x m6 x 50
VMC055 55 S	Ø 10 x m6 x 55
VMC055 60 S	Ø 10 x m6 x 60
VMC055 65 S	Ø 10 x m6 x 65
VMC055 70 S	Ø 10 x m6 x 70
VMC055 80 S	Ø 10 x m6 x 80
VMC055 90 S	Ø 10 x m6 x 90
VMC525 8 S	

00 BLACK - NERO 01 SILVER 02 BLUE - BLU 03 GOLD - ORO 04 RED - ROSSO 07 GREEN - VERDE

EXAGON HEAD SCREW

VITE TESTA ESAGONALE

Codice - Code	Misura - Measures
VMC036 10 S	Ø 12 x m6 x 10
VMC036 15 S	Ø 12 x m6 x 15
VMC036 20 S	Ø 12 x m6 x 20
VMC036 25 S	Ø 12 x m6 x 25
VMC036 30 S	Ø 12 x m6 x 30
VMC036 35 S	Ø 12 x m6 x 35
VMC036 40 S	Ø 12 x m6 x 40
VMC036 45 S	Ø 12 x m6 x 45
VMC036 50 S	Ø 12 x m6 x 50
VMC036 55 S	Ø 12 x m6 x 55
VMC036 60 S	Ø 12 x m6 x 60
VMC036 65 S	Ø 12 x m6 x 65
VMC036 70 S	Ø 12 x m6 x 70
VMC036 75 S	Ø 12 x m6 x 75
VMC036 80 S	Ø 12 x m6 x 80

Codice - Code	Misura - Measures
VMC036 85 S	Ø 12 x m6 x 85
VMC036 90 S	Ø 12 x m6 x 90
VMC036 95 S	Ø 12 x m6 x 95
VMC053 10 S	Ø 16 x m8 x 10
VMC053 15 S	Ø 16 x m8 x 15
VMC053 20 S	Ø 16 x m8 x 20
VMC053 25 S	Ø 16 x m8 x 25
VMC053 30 S	Ø 16 x m8 x 30
VMC053 35 S	Ø 16 x m8 x 35
VMC053 40 S	Ø 16 x m8 x 40
VMC053 45 S	Ø 16 x m8 x 45
VMC053 50 S	Ø 16 x m8 x 50
VMC053 55 S	Ø 16 x m8 x 55
VMC053 60 S	Ø 16 x m8 x 60

179

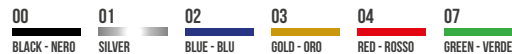

NYLON WASHER
RONDELLE NYLON

	Code - Codice
50 nylon washer inner d. 5mm 50 rondelle nylon d. interno 5mm	VMC001 5
50 nylon washer inner d. 6mm 50 rondelle nylon d. interno 5mm	VMC001 6
50 nylon washer inner d. 8mm 50 rondelle nylon d. interno 5mm	VMC001 8

Model - Modello	Year - Anno	Fairing	Engine	Fuel Cap	Screen
		Carena	Motore	Tappo serbatoio	Cupolino
APRILIA					
RSV4/R/APRC	09-20	VEC07A	VEM07A	VET01D	VEV07A
TUONO V4	11-20		VEM07A		
BMW				VET01D	
S 1000 RR	09-14	VEC01B	VEM01B	VET01D	VEV01B
	15-18		VEM01B		VEV02B
F 800 R	09-14	VEC02B	VEM02B		
DUCATI				VET01D	
748 / 916 / 996	93-03			VET01D	VEV01D
749 / 999	03-06				VEV01D
848	08-13	VEC13D	VEM15D		VEV04D
1098 / 1198	07-11	VEC13D	VEM13D		VEV04D
PANIGALE 899 / 1199	12-15	VEC16D	VEM16D	VET04H	VEV05D
MONSTER 696 / 796	08-14	VEC14D	VEM14D	VET02H	VEV05D
MONSTER S4R / S2R	03-08			VET02H	
MONSTER 1100	09-13		VEM13D	VET02H	
DIAVEL	11-18	VEC17D		VET02H	
SCRAMBLER	15-17	VEC18D	VEM18D	VET02H	
HONDA				VET02H	
CBR 600 F	95-00			VET02H	
	01-06	VEC10H		VET02H	VEV02H
	11-13	VEC25H	VEM21H	VET06H	
CBR 600 R / RR	01-03			VET04H	VEV02H
	03-04	VEC14H	VEM11H	VET02H	VEV02H
	05-06	VEC17H	VEM11H	VET02H	VEV02H
	07-08	VEC20H	VEM20H	VET02H	VEV02H
	09-12	VEC24H	VEM20H	VET02H	VEV02H
	13-16	VEC26H	VEM20H	VET05H	VEV05H
CBR 650 R	19-22		VEM28H		
CBR 900	00-01			VET04H	VEV02H
	02-03			VET02H	VEV05H
CBR 1000 R / RR	04-05	VEC15H	VEM15H	VET02H	VEV02H
	06-07	VEC19H	VEM15H	VET02H	VEV02H

Model - Modello	Year - Anno	Fairing	Engine	Fuel Cap	Screen
		Carena	Motore	Tappo serbatoio	Cupolino
	08-16	VEC22H	VEM22H	VET06H	VEV06H
	17-19	VEC27H	VEM27H	VET02H	VEV07H
CBR1000RR-R	20-22	VEC28H	VEM12H		VEV08H
VTR 1000 SP1 / 2	00-06			VET05K	VEV02H
HORNET 600	98-02	VEC18H	VEM07H		
	03-06	VEC18H	VEM16H		
	07-13	VEC21H	VEM21H	VET04K	
CB 650 R	19-22		VEM28H	VET04K	
CB 1000 R	08-17	VEC23H	VEM23H	VET04K	
KAWASAKI				VET04K	
NINJA 250 R / NINJA 300	07-17	VEC21K	VEM21K	VET04K	VEV05K
NINJA 400	18-21	VEC32K	VEM32K	VET04K	
ZX 6-636 R / RR	98-02			VET04K	VEV01K
	03-04	VEC05K		VET04K	VEV02K
	05-06	VEC11K	VEM11K	VET04K	VEV01K
	07-08	VEC15K	VEM15K	VET06K	VEV01K
	09-12	VEC20K	VEM20K	VET04K	VEV01K
	13-17	VEC27K	VEM20K	VET04K	VEV01K
ZX 10 R	04-05	VEC10K		VET04K	VEV01K
	06-07	VEC14K	VEM14K	VET04K	VEV01K
	08-10	VEC18K	VEM18K		VEV01K
	11-15	VEC24K	VEM24K	VET04K	VEV01K
	16-20	VEC29K	VEM24K	VET04K	VEV04K
Z 1000 SX	10-18	VEC25K	VEM23K		VEV01K
ZZR 1400 R	06-18	VEC19K	VEM19K	VET04K	VEV01K
ER6N	05-08	VEC13K		VET04K	
	09-11	VEC22K		VET04K	
Z 650	17-19	VEC31K	VEM31K	VET04K	
Z 750 / R / S	03-06	VEC09K	VEM09K	VET04K	VEV01K
	07-13	VEC16K	VEM16K		
Z 900	17-18	VEC30K	VEM30K	VET010	VEV04K
Z 800 / R	13-16	VEC26K	VEM16K		VEV03Y
Z 1000	03-06				VEV04K

Model - Modello	Year - Anno	Fairing	Engine	Fuel Cap	Screen
		Carena	Motore	Tappo serbatoio	Cupolino
	07-09	VEC17K	VEM17K	VET01M	VEV04K
	10-13	VEC23K	VEM23K	VET01M	VEV04K
	14-18	VEC28K	VEM23K		VEV04K
KTM				VET02S	
SUPERDUKE 1290	14-16	VEC010	VEM010	VET01S	
SUPERDUKE 1290	17-18	VEC020	VEM020	VET01S	
MV AGUSTA				VET01S	
TURISMO VELOCE	14-20	VEC05M	VEM05M	VET01S	
BRUTALE B3 E4	16-19	VEC03M	VEM03M	VET01S	
SUZUKI				VET01S	
GSX 600 R	01-03			VET01S	VEV05S
GSX 600 / 750 R	04-05	VEC18S	VEM18S	VET01S	VEV06S
	06-07	VEC22S	VEM22S	VET01S	VEV07S
	08-10	VEC25S	VEM22S	VET02S	VEV07S
	11-17	VEC30S	VEM22S	VET01S	VEV07S
GSX 1000 R	03-04			VET01S	VEV05S
	05-06	VEC19S	VEM19S	VET01S	VEV07S
	07-08	VEC24S	VEM24S	VET01S	VEV07S
	09-16	VEC27S	VEM27S	VET01S	VEV07S
	17-18	VEC35S	VEM35S	VET05S	VEV09S
GSX 1300R HAYABUSA	08-17	VEC26S	VEM26S	VET04S	
GSR 600	06-12	VEC23S	VEM23S	VET01S	
SV650	03-12			VET03S	VEV06S
	16-18	VEC33S	VEM33S		
GLADIUS 650	09-15	VEC29S	VEM29S		
GSR 750	10-16	VEC31S	VEM31S	VET02Y	
GSX -S750	17-19	VEC34S	VEM34S	VET02Y	
GSX -S1000	15-19	VEC32S	VEM32S	VET03Y	
SV 1000	03-06			VET03Y	VEV06S
B-KING	07-12	VEC28S	VEM28S	VET02Y	
YAMAHA				VET02Y	
R125	08-18	VEC18Y	VEM18Y	VET02Y	VEV01Y
R3	15-18				

Model - Modello	Year - Anno	Fairing	Engine	Fuel Cap	Screen
		Carena	Motore	Tappo serbatoio	Cupolino
R6	99-02	VEC01Y		VET02Y	VEV01Y
	03-04	VEC03Y	VEM03Y	VET02Y	VEV03Y
	05	VEC09Y	VEM03Y		VEV03Y
	06-07	VEC10Y	VEM10Y		VEV03Y
	08-16	VEC13Y	VEM10Y	VET04Y	VEV03Y
	17-20	VEC25Y	VEM25Y	VET02Y	VEV03Y
	R1	98-01			VET02Y
	02-03			VET02Y	VEV02Y
	04-06		VEM04Y	VET02Y	VEV03Y
	07-08		VEM12Y	VET02Y	
	09-14		VEM15Y	VET02Y	
	15-19	VEC23Y	VEM23Y	VET02Y	VEV03Y
TDM 900	02-14	VEC16Y	VEM16Y		VEV04Y
XJ6	09-15	VEC17Y	VEM17Y	VET04Y	
FZ6	04-11	VEC08Y	VEM08Y		
FZ8	10-16	VEC19Y	VEM19Y		
FZ1	06-15	VEC11Y	VEM11Y		
MT07	14-17	VEC22Y	VEM22Y	VET01T	
MT09	13-16	VEC21Y	VEM21Y	VET01T	
	17-21	VEC26Y	VEM26Y	VET01T	
MT10	16-21	VEC24Y	VEM24Y	VET01T	
T-MAX	08-11	VEC14Y	VEM14Y	VET01T	
	12-16	VEC20Y		VET01T	
TRIUMPH					
DAYTONA 675 / R	06-12		VEM03T		VEV02T
	13-16		VEM03T		
STREET TRIPLE / R	07-12	VEC03T	VEM03T		
	13-15	VEC06T	VEM03T		
SPEED TRIPLE / R	05-10	VEC04T	VEM04T		
	11-15	VEC05T	VEM05T		



Valter Moto Components is a brand of VComponents s.r.l. Unipersonale

Via dell'Immacolata, 1 | Carate Brianza (MB) - 20841 | ITALIA

✉ info@valtermoto.com | ☎ +39 0362.805407

valtermoto.com

